

SET UP INSTRUCTION

Expolinc Frame

BASIC SET UP

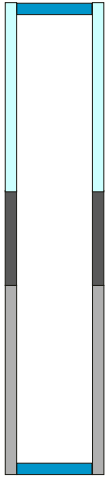
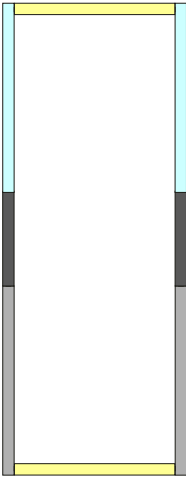
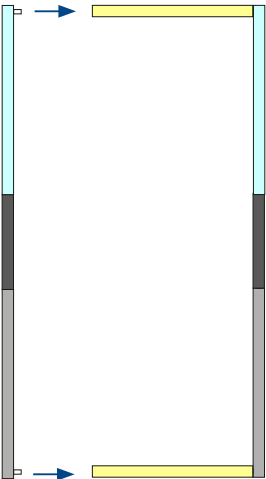
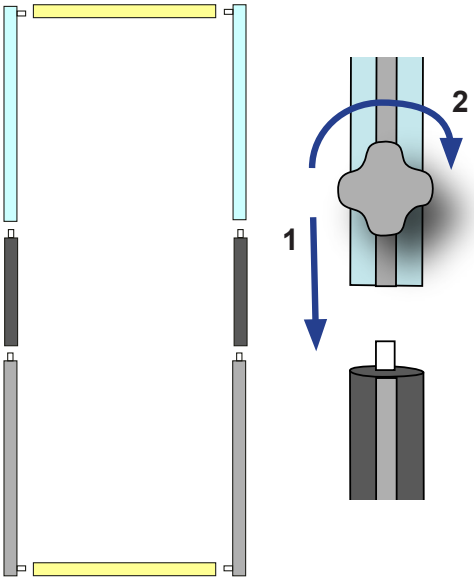
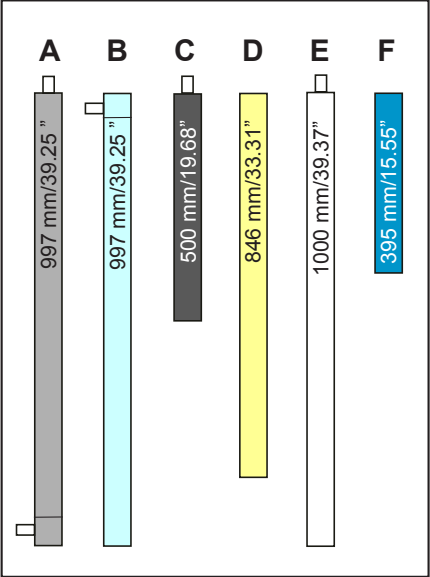

WIDTHS & HEIGHTS

- + 500 mm/19.68"
- + 1000 mm/39.37"

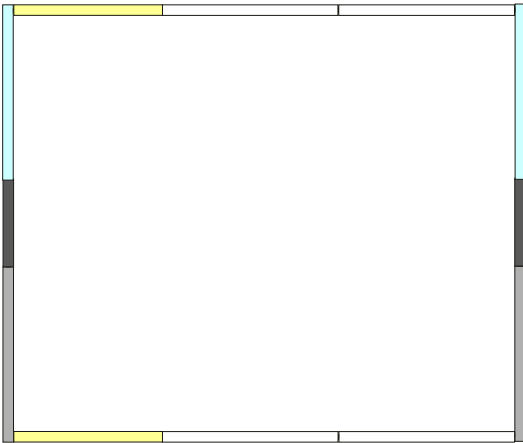
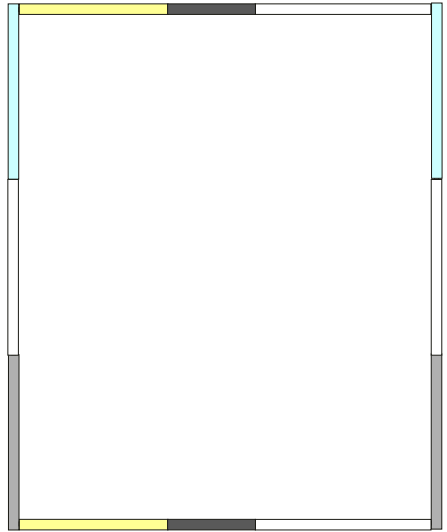
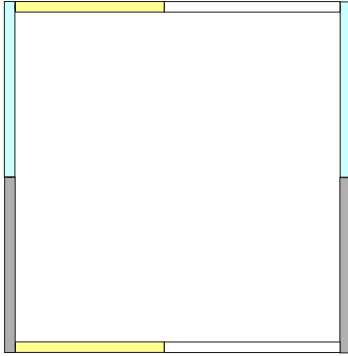
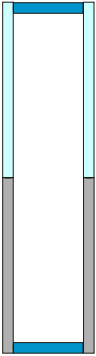

SUPPORTING ROD

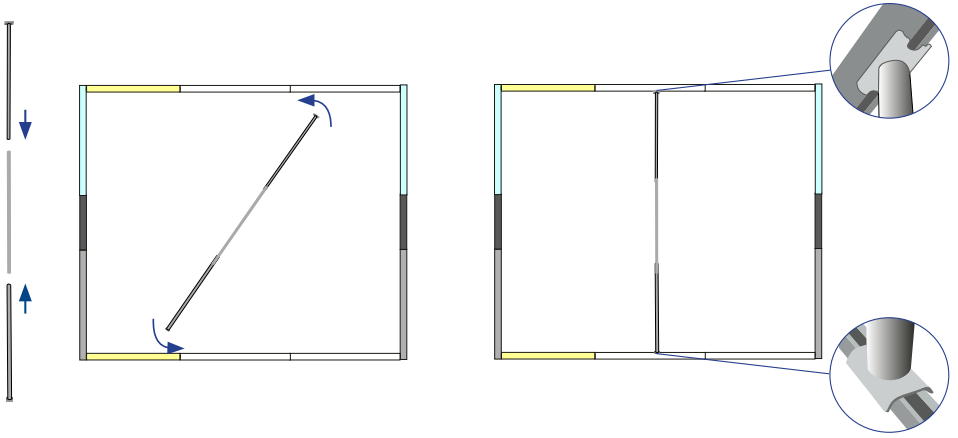

MOUNT THE GRAPHIC

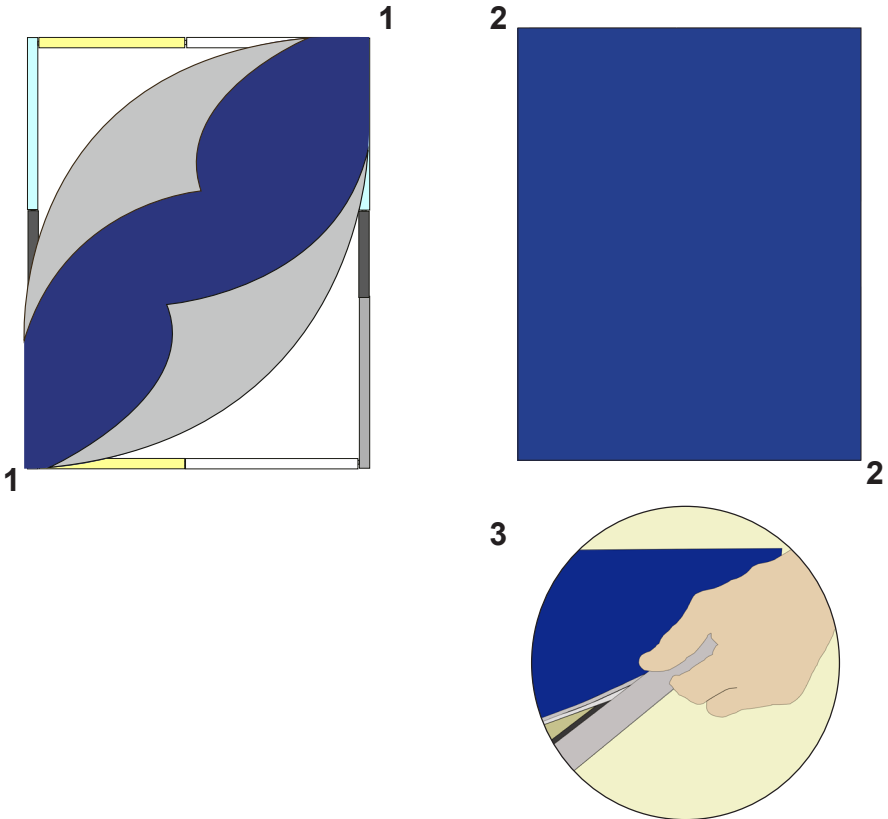

STABILISING FEET

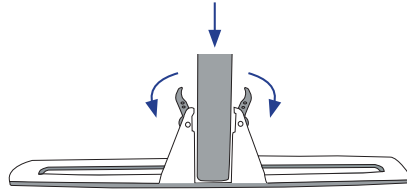

Standard foot

Double-sided

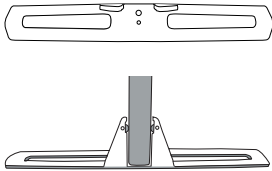

Single-sided

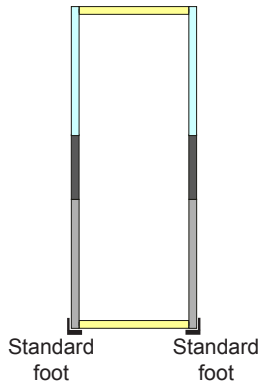
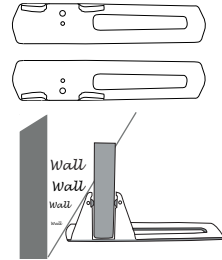

Double-sided

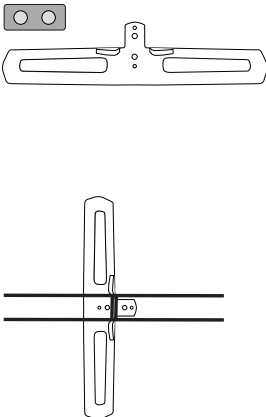

Single-sided

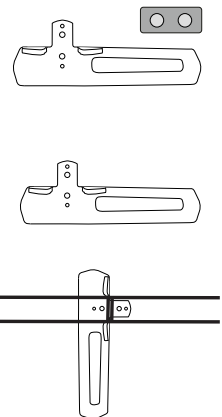

Connecting foot

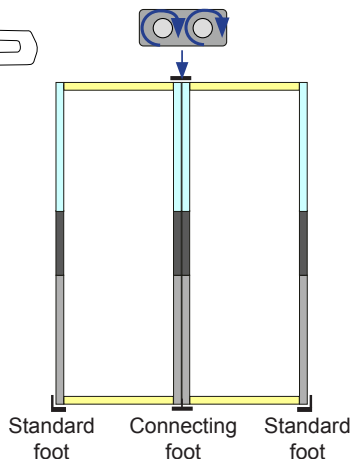

CONNECTORS

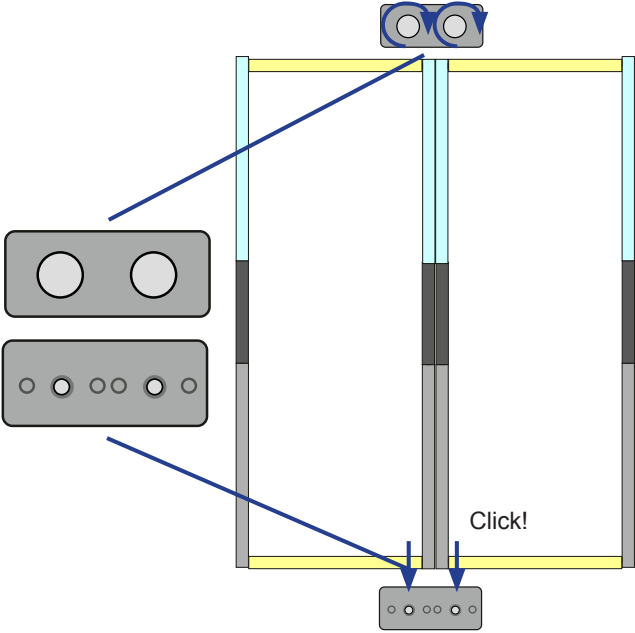

90° type A

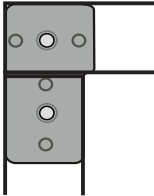

90° type B

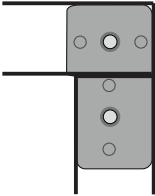

Straight

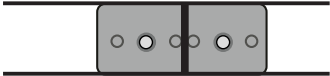

Triple A

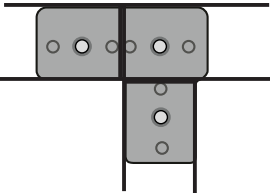

Triple B

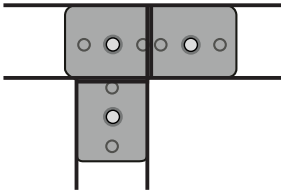

Triple C

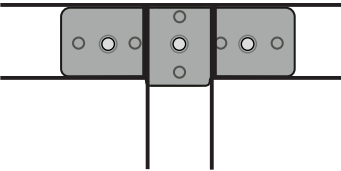

SPOTLIGHT

