





**Prodir.****Well-made, well done.**

Warum sich für einen Kugelschreiber von Prodir entscheiden? Weil Prodir alles in sich vereint. Wir designen, produzieren, vertreiben und forschen. Denn Prodir liebt Design. Ikonische Formen, perfekte Details. Da Prodir an Ihre Marke glaubt. Wir arbeiten mit unseren Kunden zusammen, um die besten Ergebnisse zu erzielen. Denn Prodir stellt eine vielschichtige Welt dar. Rational und perfekt. Genau wie ein Kugelschreiber.  
Prodir. Well made, well done.

**Prodir.****Well-made, well done.**

Pourquoi choisir un stylo Prodir? Parce que Prodir se charge de tout. Nous assurons le design, la fabrication, la distribution et la recherche. Parce que Prodir aime le design. Formes emblématiques, détails impeccables. Parce que Prodir croit dans votre marque. Nous travaillons de concert avec nos clients, pour les meilleurs résultats. Parce que Prodir est un monde complexe. Rationnel et parfait, comme un stylo.  
Prodir. Well made, well done.

**Prodir.****Well-made, well done.**

¿Por qué optar por un bolígrafo Prodir? Porque Prodir hace todo. Diseñamos, producimos, distribuimos e investigamos. Porque Prodir ama el diseño. Siluetas icónicas, detalles impecables. Porque Prodir cree en su marca. Trabajamos codo a codo con nuestros clientes para alcanzar los mejores resultados. Porque Prodir es un mundo complejo. Racional y perfecto, al igual que un bolígrafo.  
Prodir. Well made, well done.

**Prodir.****Well-made, well done.**

Perché scegliere una penna Prodir? Perché Prodir fa tutto da sola. Progetta, produce, distribuisce, ricerca. Perché Prodir ama il design. Forme iconiche, dettagli impeccabili. Perché Prodir crede nei tuoi progetti. Accanto al cliente, per il miglior risultato. Perché Prodir è un mondo complesso. Razionale e perfetto, come una semplice penna.  
Prodir. Well made, well done.

**Prodir.****Well-made, well done.**

Почему стоит выбрать ручку Prodir? Потому что компания Prodir способна на все. Мы создаем дизайн, осуществляем производство, организуем сбыт и проводим исследования. Потому что компания Prodir с любовью относится к дизайну. Стильные формы, безукоризненно выполненные элементы. Потому что компания Prodir верит в вашу торговую марку. Мы тесно сотрудничаем со своими заказчиками для получения непревзойденных результатов. Потому что компания Prodir – это сложный мир. Рациональный и безупречный, как и ее ручки.  
Prodir. Well made, well done.

**Prodir. Well made, well done.**

Why choose a Prodir pen?

Because Prodir does it all. We design, produce, distribute and research. Because Prodir loves design. Iconic shapes, impeccable details.

Because Prodir believes in your brand.

We work alongside our clients, for the best results. Because Prodir is a complex world.

Rational and perfect, just like a pen.

Prodir. Well Made, well done.



### **Write, not type.**

We learn to write as children, when we can still absorb thousands of new words per minute. Our young brains focus on the movements. The mind and body come together as we write. We will use computers, tablets and smartphones more and more, but when we really need to clarify ideas, define concepts and make decisions, we do so with a pen in our hands. And it feels right.



**Schreiben,  
nicht tippen.**

Als Kinder, wenn wir noch tausende Worte pro Minute in uns aufnehmen können, lernen wir zu schreiben. Unsere jungen Gehirne konzentrieren sich auf die Bewegungen. Der Körper und der Geist kommen zusammen, wenn wir schreiben. Wir verlassen uns immer mehr auf Computer, Tablets und Smartphones. Wenn wir aber wirklich Ideen ausdrücken, Konzepte bestimmen und Entscheidungen fällen müssen, so tun wir das mit einem Stift in der Hand. Und das fühlt sich richtig an.

**Écrire, ne pas taper.**

Enfants, nous apprenons à écrire à un moment où nous sommes en mesure d'absorber des milliers de mots nouveaux par minute. Nos jeunes cerveaux se concentrent sur les mouvements. L'esprit et le corps se rejoignent au moment où nous écrivons. Aujourd'hui, nous comptons de plus en plus sur les ordinateurs, les tablettes et les smartphones, mais lorsque nous avons vraiment besoin de clarifier des idées, de définir des concepts et de prendre des décisions, nous le faisons avec un stylo à la main. Et cela semble juste.

**Escribir no es lo mismo que teclear.**

Aprendemos a escribir de niños, cuando aún somos capaces de asimilar muchas palabras nuevas por minuto. Nuestros jóvenes cerebros, ávidos de conocimiento, se concentran en el movimiento de la mano. La mente y el cuerpo se fusionan al escribir. Es cierto que ordenadores, tabletas y smartphones desempeñan un papel cada vez más importante en nuestras vidas. Sin embargo, cuando realmente necesitamos clarificar ideas, definir conceptos y tomar decisiones, tomamos un bolígrafo. Un gesto que nos da seguridad.

**Scrivere, non digitare.**

Impariamo a scrivere a mano da piccoli, quando la nostra mente è in grado di apprendere migliaia di parole al minuto. Il nostro cervello di bambini si concentra sul gesto. Mente e corpo si toccano: scrivendo, cominciano a parlarsi. Sempre più spesso useremo computer, tablet, smartphone, ma ogni volta che dovremo consolidare concetti, chiarire idee, prendere decisioni lo faremo impugnando una penna. E ci sentiremo al sicuro.

**Пишите,  
а не печатайте.**

Мы учимся писать, будучи детьми, когда мы в состоянии впитывать тысячи новых слов в минуту. Наш молодой мозг концентрируется на движениях. При письме мозг и тело работают как единое целое. Мы все чаще используем компьютеры, планшеты и смартфоны. Но, когда возникает необходимость по-настоящему прояснить идеи, определить понятия и принять решения, мы берем в руки ручку. И это правильно.



## One pen, many lives.

Is there anything simpler, more useful and more familiar than a pen? We always have one with us – you never know when you'll need it. A pen can be given, found, lent and refilled. A pen can be lost. A pen can have a hundred lives if it's designed to last. And the message it carries will reach hundreds of people. All it needs is a strong body, a tough tip, a replaceable refill and a timeless design.

### Ein Kugelschreiber, viele Leben.

Gibt es etwas Einfacheres, Nützlicheres und Gewohnteres als einen Kugelschreiber? Wir tragen immer einen bei uns - man weiß nie, wann man ihn braucht. Ein Kugelschreiber kann verschenkt, gefunden, verliehen und nachgefüllt werden. Ein Kugelschreiber kann verloren werden. Ein Kugelschreiber kann hunderte Leben haben, wenn er dafür gemacht ist zu halten. Und die Botschaft, die er trägt, wird Hunderte von Menschen erreichen. Alles, was man benötigt, ist ein stabiler Korpus, eine robuste Spitze, erneuerbare Minen und ein zeitloses Design.

### Un stylo, de nombreuses vies.

Y a-t-il quelque chose de plus simple, utile et familier qu'un stylo ? Nous en avons toujours un sur nous - on ne sait jamais quand on en aura besoin. Un stylo peut être donné, trouvé, prêté et rechargé. Un stylo peut être perdu. Un stylo peut avoir cent vies s'il a été conçu pour durer. Et le message qu'il véhicule atteindra alors des centaines de personnes. Tout ce dont il a besoin, c'est d'un corps solide, d'une pointe robuste, d'une recharge remplaçable et d'un design intemporel.

### Un bolígrafo, infinidad de vidas.

¿Hay algo más sencillo, útil y familiar que un bolígrafo? Siempre llevamos uno a mano, quién sabe cuando nos hará falta. Un bolígrafo se puede regalar, encontrar, pedir prestado y rellenar con un recambio. Es posible perder un bolígrafo. Un bolígrafo puede tener cien vidas, pues está diseñado para durar. Y el mensaje que transmite puede alcanzar a cientos de personas. Solo precisa una carcasa fuerte, una punta robusta, una mina recambiable y un diseño atemporal.

### Una penna, molte vite.

Cosa c'è di più semplice, utile, quotidiano di una penna? Ne abbiamo una sempre con noi perché può servire in ogni momento. Una penna si regala, si trova, si ricarica, si presta. Una penna si perde. Quando è progettata per durare, può avere centinaia di vite. Il messaggio che porta con sé raggiunge centinaia di persone. Ci vogliono un corpo solido, una puntina resistente, un refill sostituibile, un design che non invecchia.

### Одна ручка, множество жизней.

Существует ли что-нибудь более простое, полезное и знакомое, чем ручка? Одна из них всегда при нас, ведь никогда не известно, когда она может понадобиться. Ручку можно подарить, найти, дать во временное пользование или заправить чернилами. Ручку можно потерять. Ручка может прожить сотни жизней, если ее конструкция создается на века. Сообщение, которое она несет, может дойти до сотен людей. Все, что для этого нужно, – прочный корпус, прочное перо, заменяемое устройство для заправки и неподвластный времени дизайн.



# Pagani/pens

## Pagani Pens, since 1961.

Prodir, along with brand Premec, is part of the renowned Pagani Pens group, a Swiss company that has been producing writing instruments and parts since 1961. With over 50 years of experience, Pagani Pens has developed a solid business culture and created high-quality products. Today it has over 500 collaborators around the world and is present in over 50 countries. The Group's focus is on client needs, customised detailing, technological product innovation and respect for the environment and our employees.

### Pagani Pens, seit 1961.

Prodir ist gemeinsam mit der Marke Premec Teil der berühmten Pagani Pens Gruppe, eines schweizerischen Unternehmens, das seit 1961 Schreibinstrumente und -zubehör herstellt. Auf Grundlage von über 50 Jahren Erfahrung hat Pagani Pens eine solide Unternehmenskultur und hochwertige Produkte kreiert. Heute hat das Unternehmen weltweit mehr als 500 Partner und ist in über 50 Ländern präsent. Das Hauptinteresse des Unternehmens liegt auf den Bedürfnissen der Kunden, speziell entworfenen Details, technischer Produktinnovation und Respekt für die Umwelt und seine Angestellten.

### Pagani Pens, depuis 1961.

Prodir fait partie, avec la marque Premec, du célèbre groupe Pagani Pens, une entreprise suisse qui fabrique des instruments d'écriture et des composants depuis 1961. Avec plus de 50 ans d'expérience, Pagani Pens a développé une solide culture d'entreprise et créé des produits de haute qualité. Aujourd'hui, le Groupe compte plus de 500 collaborateurs à travers le monde et est présent dans plus de 50 pays. Il met l'accent sur les besoins de ses clients, la personnalisation des détails, l'innovation technologique des produits et le respect de l'environnement et de ses collaborateurs.

### Pagani Pens, desde 1961.

Prodir, junto con la marca Premec, forma parte del conocido grupo Pagani Pens, una empresa suiza que fabrica instrumentos de escritura y componentes desde 1961. Avalada por 50 años de experiencia, Pagani Pens ha desarrollado una sólida cultura corporativa y lanzado al mercado productos de calidad superior. En la actualidad, cuenta con más de 500 colaboradores en todo el mundo y está presente en más de 50 países. La filosofía de Pagani Pens Group se centra en satisfacer las necesidades del cliente, en la personalización mediante los detalles, la innovación tecnológica del producto y el respeto por el medioambiente y por sus empleados.

### Pagani Pens, dal 1961.

Prodir, insieme al brand Premec, fa parte del grande gruppo Pagani Pens, azienda svizzera che dal 1961 produce strumenti e componenti di scrittura. In oltre cinquant'anni di esperienza, Pagani Pens ha sviluppato una solida cultura d'impresa ed esportato prodotti d'eccellenza. Oggi conta più di 500 collaboratori nel mondo ed è presente in oltre 50 paesi. Mette al centro le esigenze del cliente, la personalizzazione del dettaglio, l'innovazione tecnologica del prodotto, il rispetto per l'ambiente e i lavoratori.

### Pagani Pens, с 1961 года.

Prodir, наряду с торговой маркой Premec, является частью большой группы компаний Pagani Pens из Швейцарии, которая занимается изготовлением письменных принадлежностей с 1961 года. Более чем за 50 лет работы группа компаний создала устойчивую корпоративную культуру и разработала высококачественную продукцию. Сегодня штат ее сотрудников по всему миру насчитывает более 500 человек. Корпорация представлена более чем в 50 странах мира. В центре ее внимания – потребности заказчиков, изготовление продукции по индивидуальному заказу, технологические инновации, уважение к окружающей среде и собственным сотрудникам.





## Material matters.

Prodir pens are functional and versatile. They are made from high-quality plastic that is carefully selected and designed to last. Their solid and resistant bodies hide a sustainable heart, thanks to constant dialogue between technique and innovation, control and creativity.

### Das Material spielt eine Rolle.

Prodir Kugelschreiber sind funktionell und vielseitig. Sie werden aus qualitativ hochwertigem Kunststoff hergestellt, der sorgfältig ausgewählt wird und für eine lange Lebensdauer ausgelegt ist. Ihre soliden und widerstandsfähigen Körper beherbergen dank des ständigen Austauschs zwischen Technik und Innovation sowie Kontrolle und Kreativität eine grüne Seele.

### Les matériaux sont importants.

Les stylos Prodir sont fonctionnels et polyvalents. Ils sont fabriqués en matière plastique de haute qualité, soigneusement sélectionnée et conçue pour durer. Leurs corps solides et résistants dissimulent un cœur durable, grâce au dialogue constant entre technique et innovation, contrôle et créativité.

### El material importa.

Los bolígrafos Prodir son funcionales y versátiles. Están fabricados con plástico de calidad superior, seleccionado cuidadosamente y diseñado para durar mucho tiempo. Sus carcasas, sólidas y resistentes, albergan un núcleo "sostenible" gracias al diálogo continuo entre técnica e innovación, control y creatividad.

### I materiali contano.

Le penne Prodir sono funzionali e versatili, realizzate con plastica di qualità, selezionata con la massima cura e progettata per durare. Hanno un corpo solido e resistente che nasconde un'anima sostenibile, frutto del costante dialogo tra tecnica e innovazione, controllo e creatività.

### Материал имеет значение.

Ручки Prodir отличаются функциональностью и универсальностью. Они изготавливаются из высококачественных пластмасс, которые тщательно отбираются и создаются на века. В сердце надежного и прочного корпуса – зеленые технологии. Это является результатом непрерывного диалога между техникой и инновациями, управлением и творчеством.



### **Well made, Swiss made.**

We are Swiss. And our pens are entirely produced in Switzerland. Our company is founded on our business culture and respect for the environment and our work. These are the values that we believe in, that we uphold every day and that represent the future we want.

**Well-made, Swiss Made.**

Wir sind Schweizer. Und unsere Kugelschreiber werden vollständig in der Schweiz hergestellt. Unser Schaffen beruht auf unserer Unternehmenskultur sowie unserem Respekt für die Umwelt und unsere Arbeit. Das sind die Werte, an die wir glauben, die wir jeden Tag aufrecht erhalten und die die Zukunft verkörpern, die wir uns wünschen.

**Well-made, Swiss Made.**

Nous sommes Suisses. Et nos stylos sont entièrement fabriqués en Suisse. Notre firme est fondée sur notre culture d'entreprise et le respect de l'environnement et de notre travail. Ce sont les valeurs auxquelles nous croyons, que nous défendons quotidiennement et qui représentent l'avenir que nous voulons.

**Well-made, Swiss Made.**

Somos suizos. Y nuestros bolígrafos están fabricados íntegramente en Suiza. Nuestros pilares son nuestra cultura corporativa y el respeto por la naturaleza y por nuestro trabajo. Son los valores en los que creemos, que llevamos a la práctica día a día y que representan el futuro que deseamos.

**Well-made, Swiss Made.**

Siamo svizzeri. E le nostre penne sono interamente prodotte in Svizzera. Il rispetto per l'ambiente e il lavoro, e la cultura responsabile d'impresa sono le basi su cui abbiamo costruito la nostra azienda, sono i valori in cui crediamo e con cui ci confrontiamo ogni giorno e rappresentano il futuro che vogliamo.

**Well-made, Swiss Made.**

Мы – швейцарская торговая марка. Наши ручки целиком и полностью изготавливаются в Швейцарии. Наша организация построена на корпоративной культуре, а также на уважении к окружающей среде и собственной работе. Это – ценности, в которые мы верим и которых придерживаемся каждый день. Ценности, которые воплощают для нас будущее, к которому мы стремимся.

**Zeitloses Design.**

Moderne und sehr klare Designs, die in Harmonie mit den Materialien und den Bedürfnissen der Menschen, die sie benutzen, entwickelt werden. Prodir Kugelschreiber verkörpern Persönlichkeit: Ikonisch und originell verbinden sie Stil und Funktion sowie künstlerisches Wissen und technische Innovation. Dieses Jahr feiert Prodir das Jubiläum seiner unverwechselbaren gefrosteten Oberfläche, eines weiteren Meilensteins, den Prodir zu seinen vielen Errungenschaften in Sachen Kommunikation und Design hinzufügen kann, und einer Bestätigung dafür, dass dieses zukunftsweisende Unternehmen mehr als fähig genug ist, neue moderne Trends zu interpretieren.

**Design intemporel.**

Des designs contemporains et essentiels, développés en harmonie avec les matières employées et les besoins des personnes qui les utilisent. Les stylos Prodir incarnent une personnalité : emblématiques et originaux, ils allient style et fonctionnalité, savoir artisanal et innovation technologique. Cette année, Prodir célèbre les 20 ans de la surface givrée, à l'apparence unique, une nouvelle étape décisive qui vient s'ajouter à ses nombreuses réalisations en matière de communication et de design et qui confirme que cette entreprise pionnière est plus que capable d'interpréter les tendances contemporaines.

**Diseño atemporal.**

Diseños actuales y dinámicos, desarrollados en armonía con los materiales empleados y con las necesidades de las personas que los utilizarán. Los bolígrafos Prodir tienen su propia personalidad —icónica y original— y aún estilo y función, saber artesanal e innovación tecnológica. Este año, Prodir celebra el 20 aniversario de su inconfundible superficie Frosted, un hito más de los numerosos logros en comunicación y diseño que ponen de manifiesto que esta innovadora empresa interpreta a la perfección las tendencias contemporáneas.

**Design senza tempo.**

Un design contemporaneo ed essenziale, che nasce insieme ai materiali che modella e alle esigenze di chi lo utilizzerà. Le penne Prodir sono campionesse di personalità: iconiche e originali, coniugano bellezza e funzionalità, sapienza artigiana e innovazione tecnologica. Quest'anno Prodir celebra vent'anni della sua inconfondibile superficie Frosted, un primato che si aggiunge ai numerosi riconoscimenti ottenuti nell'ambito della comunicazione e design, e che ne conferma il ruolo di azienda pioniera, capace di interpretare le tendenze contemporanee.

**Неподвластный времени дизайн.**

Современный и актуальный дизайн, создаваемый в гармонии с используемыми материалами и потребностями людей, для которых предназначена продукция. Ручки Prodir воплощают в себе индивидуальный подход. Они отличаются стильным и оригинальным дизайном, изысканностью и функциональностью и изготавливаются с традиционным применением ручного труда и технологических инноваций. В этом году компания Prodir отмечает 20-летие своего уникального изобретения: матированной поверхности. Это – всего лишь еще одна веха на длинном пути достижений в области взаимодействия и дизайна, а также подтверждение того факта, что компания способна правильно интерпретировать современные тенденции.



20

20th  
Anniversary  
of Frosted  
Surface

**Timeless design.**

Contemporary and essential designs, developed in harmony with the materials used and the needs of the people who use them. Prodir pens embody personality: iconic and original, they combine style and function, artisanal knowledge and technological innovation. This year, Prodir is celebrating 20 years of its unmistakable Frosted surface, yet another milestone to add to its many achievements in communication and design and confirmation that this pioneering company is more than capable of interpreting contemporary trends.



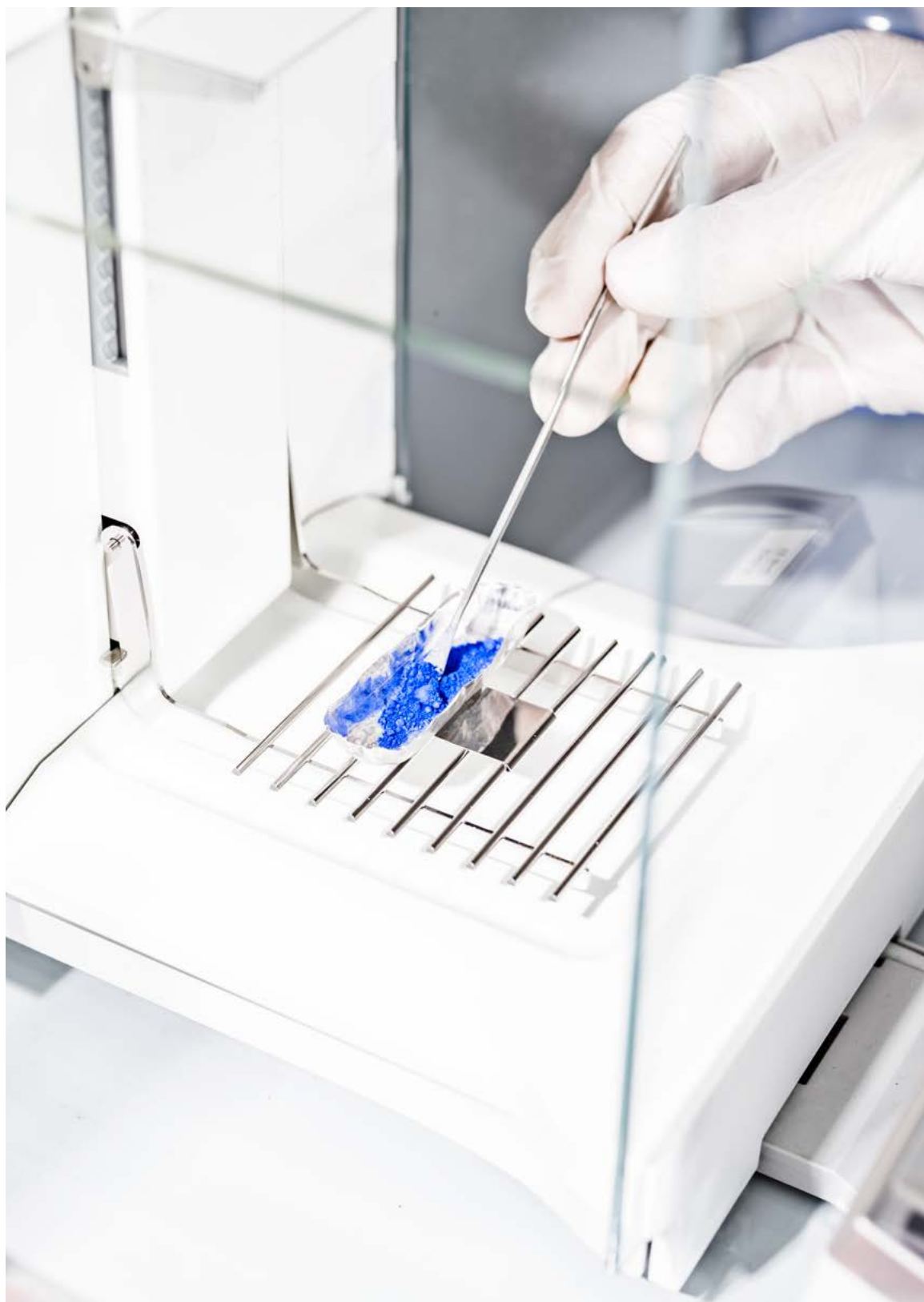

## What's in a pen?

Every pen is different. And that goes for what's on the inside too. The secrets behind a timeless writing instrument? Advanced technology, differentiated inks and top-quality refills. Impeccable quality control ensures perfect miniscule components, for a product that is unrivalled down to the very last detail.

### Was steckt in einem Kugelschreiber?

Jeder Kugelschreiber ist anders. Und das gilt auch für sein Innenleben. Welche Geheimnisse schlummern in diesem zeitlosen Schreibinstrument? Fortschrittliche Technologie, unverwechselbare Tinten und hochwertige Ersatzminen. Unsere tadellose Qualitätskontrolle stellt bei den kleinsten Bauteilen Perfektion sicher, damit das Produkt bis hin zum winzigsten Detail unübertroffen bleibt.

### Qu'y a-t-il dans un stylo?

Chaque stylo est différent. Et cela vaut aussi pour l'intérieur. Les secrets d'un instrument d'écriture intemporel? Une technologie avancée, des encres spécifiques et des recharges de qualité supérieure. Un contrôle de qualité impeccable garantit la perfection des composants, même les plus petits, pour un produit inégalé jusque dans les moindres détails.

### ¿Qué hay en un bolígrafo?

Cada bolígrafo es distinto. Y también su interior. ¿El secreto de un instrumento de escritura atemporal? Avanzada tecnología, inconfundibles tintas y recambios premium. Y un control exhaustivo de calidad que garantiza la perfección hasta en los componentes más minúsculos, para lograr un producto sin igual hasta en el último detalle.

### Cosa si nasconde in una penna?

Una penna è diversa da tutte le altre anche per quello che contiene. Tecnologie avanzate, inchiostri differenziati e refill di primissima qualità: questo è il segreto di bellezza di uno strumento di scrittura intramontabile. Componenti minuscoli e perfetti, risultato di un controllo qualità impeccabile, per un prodotto senza pari, curato in ogni dettaglio.

### Что находится внутри ручки?

Каждая ручка является уникальной. Это же относится и к ее внутреннему устройству. Какие секреты может таить неподвластный времени инструмент для письма? Усовершенствованная технология изготовления, разные чернила и устройства для заправки высочайшего качества. Безупречная система контроля качества гарантирует идеальное изготовление миниатюрных компонентов, что позволяет создавать непревзойденную продукцию даже в мельчайших деталях.

## The shape of writing.

If a pen is designed and built to be the very best, then the plans and projects of its owner have an equally winning chance. Through precise and targeted personalisation, Prodir guarantees a product that will emphasise and underline your brand's strengths. An example? The QS range, where our injection technique creates a three-dimensional design on the body of the pen. A small detail, maximum personalisation.

well made, well done.

### Die Form des Schreibens.

Wenn ein Kugelschreiber dafür gemacht ist, der Beste zu sein, haben die Pläne und Projekte seines Besitzers dieselben Erfolgsaussichten. Prodir garantiert durch präzise und gezielte Personalisierung ein Produkt, das die Stärken Ihrer Marke unterstreichen und hervorheben wird. Ein Beispiel? Die QS-Linie, bei der unsere Einspritztechnik ein dreidimensionales Design auf dem Korpus des Kugelschreibers kreiert. Ein kleines Detail, maximale Personalisierung.

### La forme de l'écriture.

Si un stylo est conçu et fabriqué pour être le meilleur, alors les plans et projets de celui dont il porte le message ont la même chance de gagner. Grâce à une personnalisation précise et ciblée, Prodir vous garantit un produit qui met en valeur et souligne les atouts de votre marque. Un exemple ? La gamme QS où notre technologie d'injection crée un design tridimensionnel sur le corps du stylo. Un petit détail, un maximum de personnalisation.

### La impronta de la escritura.

Si un bolígrafo está diseñado y fabricado para ser el mejor de los mejores, los planes y proyectos de su propietario tienen también unas perspectivas muy prometedoras. Gracias a estrategias de personalización precisas y definidas, Prodir garantiza un producto que resaltará las fortalezas de su marca. ¿Un ejemplo? La serie QS, con un diseño tridimensional de la carcasa creado con nuestra técnica de inyección. Un pequeño detalle, con una personalización máxima.

### La forma della scrittura.

Se una penna è pensata e costruita nel migliore dei modi possibili, ha tutte le caratteristiche perché anche i progetti di chi la sceglie siano altrettanto vincenti. Attraverso un'attenta e mirata personalizzazione, Prodir valorizza i punti di forza di un brand e garantisce un prodotto che ne esalti le specificità. Un esempio? La linea QS, in cui il procedimento a iniezione crea un disegno tridimensionale direttamente sul corpo della penna: un piccolo dettaglio, il massimo della personalizzazione.

### Форма письма.

Если ручка разрабатывается и изготавливается для того, чтобы стать лучшей, планы и проекты ее владельца имеют такие же высокие шансы на успех. Точная и тщательно выверенная индивидуализация гарантирует, что ручка Prodir подчеркнет силу вашей торговой марки. Нужен пример? Таким примером могут служить ручки серии QS, корпус которых отличается трехмерным дизайном, создаваемым с применением технологии литья под давлением. Тонкая детализовка, максимум индивидуализации.







# DNA. Identity Pen.

Identity? A matter of choices.  
 Personalisation? A matter of possibility.  
 Design? A matter of details.  
 Prestige? A matter of materials.



## DNA. Identity Pen.

Identität? Eine Frage der Wahl.  
 Personalisierung? Eine Frage der Möglichkeiten.  
 Design? Eine Frage der Details.  
 Prestige? Eine Frage der Materialien.

## DNA. Identity Pen.

Identité ? Une question de choix.  
 Personnalisation ? Une question de possibilités.  
 Design ? Une question de détails.  
 Prestige ? Une question de matériaux.

## DNA. Identity Pen.

¿Identidad? Una cuestión de opciones.  
 ¿Personalización? Una cuestión de posibilidades.  
 ¿Diseño? Una cuestión de detalles.  
 ¿Prestigio? Una cuestión de materiales.

## DNA. Identity Pen.

L'identità? Una questione di scelte.  
 La personalizzazione? Una questione di possibilità.  
 Il design? Una questione di dettagli.  
 Il prestigio? Una questione di materiali.

## DNA. Identity Pen.

Индивидуальность? Все дело в выборе.  
 Персонализация? Все дело в возможностях.  
 Конструкция? Все дело в деталях.  
 Престиж? Все дело в материалах.







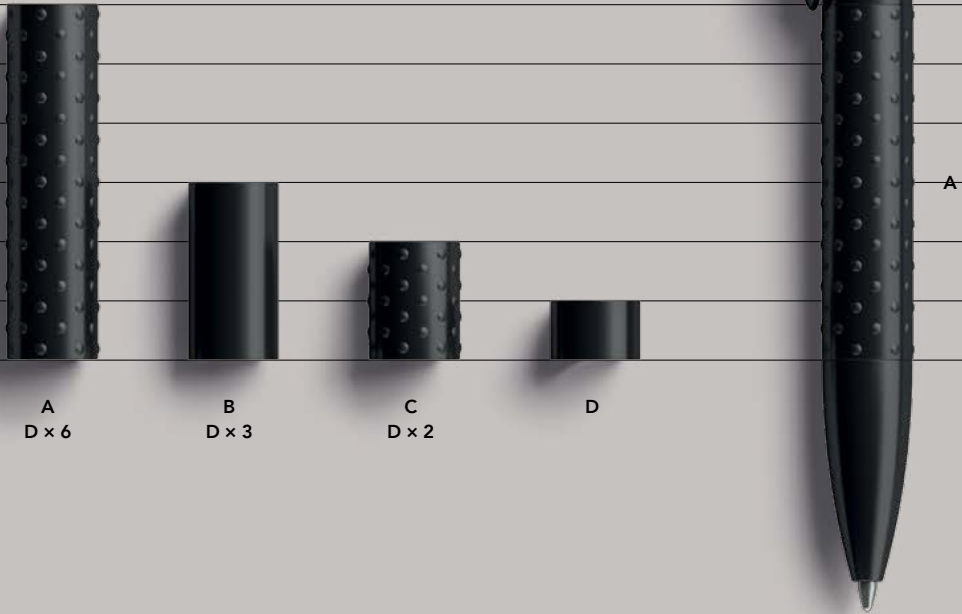

### Change your DNA.

Kräftige Farben vereinen sich mit feineren Farbnuancen, innovative Materialien gehen Kombinationen mit Gehäuseoberflächen ein, die für ein komfortables Schreiberlebnis sorgen, während luxuriöse Oberflächenbearbeitungen mit dreidimensionalen Strukturen abwechseln. Mit über 60 untereinander austauschbaren Elementen repräsentiert der neue DNA Kugelschreiber jede einzelne Nuance Ihrer Identität und hält immer Schritt mit Ihrer persönlichen Note.

### Change your DNA.

Un mix de couleurs audacieux, avec des tons plus raffinés et des matériaux innovants. Combiné à des surfaces qui offrent une expérience d'écriture confortable et à de luxueuses finitions alternant avec des motifs 3D originaux. Avec plus de 60 éléments interchangeables, le nouveau DNA reflète chaque nuance de votre identité et évolue avec vous.

### Change your DNA.

Colores atrevidos mezclados con tonos más refinados, materiales innovadores combinados con superficies que garantizan una experiencia cómoda de escritura y acabados de lujo que se alternan con originales motivos tridimensionales. Con más de 60 elementos intercambiables, el nuevo DNA siempre será su compañero fiel que representará a la perfección cada matiz de su identidad.

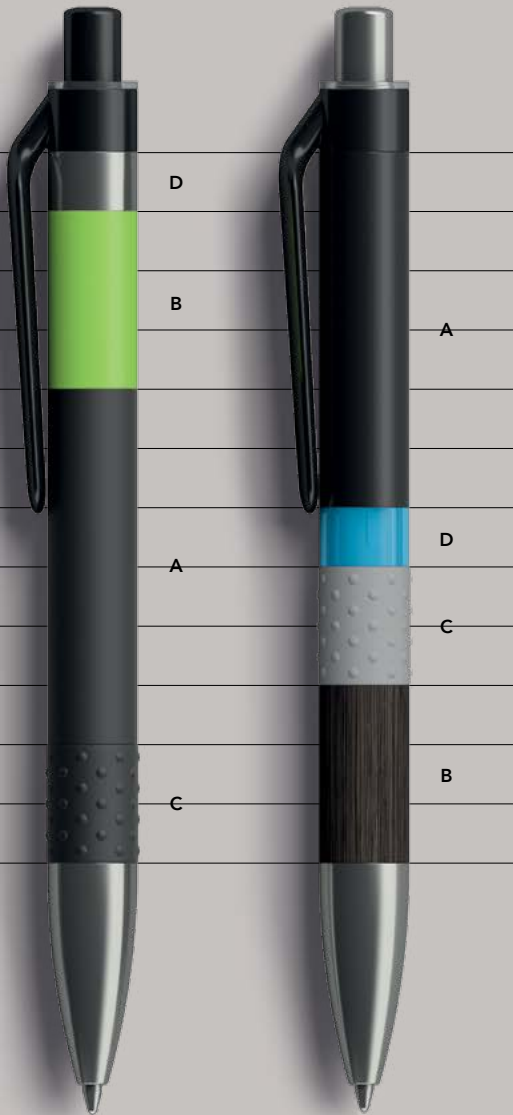

## Change your DNA.

Bold colours mix with more refined tones, innovative materials combine with surfaces that guarantee a comfortable writing experience and luxurious finishes alternate with original 3D patterns. With over 60 interchangeable elements, the new DNA will represent every single nuance of your identity and will never fail to keep up with you.

### Change your DNA.

Colori vivaci si alternano a tonalità raffinate, materiali innovativi a superfici che garantiscono un'esperienza di scrittura confortevole, finiture di pregio a originali pattern 3D. Con oltre 60 elementi intercambiabili, la nuova DNA è in grado di esplorare tutte le sfumature dell'identità ed essere sempre all'altezza di chi la sceglie.

### Change your DNA.

Смелые цвета смешиваются с более изысканными тонами, инновационные материалы сочетаются с поверхностями, которые гарантируют комфорт при письме, а роскошные варианты отделки чередуются с оригинальными трехмерными узорами. Благодаря наличию более чем 60 взаимозаменяемых элементов новая ручка DNA способна выразить каждый отдельный нюанс вашей индивидуальности и никогда не отстанет от вас на пути к развитию.

## DS8 with metal nose cone.

The DS8 has always been one of Prodir's most iconic and best-beloved products. It is now available with a deluxe feature: a metal nose cone to enhance its triangular body and, in the Metal Clip version, is elegantly combined with the clip and button. An absolutely perfect pen where the body, composed of one single compact element, rests directly on the nose cone. Available in either silver, copper, black or graphite and with a chrome or satin finish. Minimum elements, infinite variety: this is the harmonious balance found at Prodir.



### DS8 mit Metallspitze.

Den DS8, eines der kultverdächtigsten und beliebtesten Schreibgeräte von Prodir, gibt es jetzt mit einem Deluxe-Feature: Eine Metallspitze verstärkt das Dreiecksgehäuse und geht in der Version Metal Clip eine elegante Kombination mit Clip und Druckknopf ein. Ein absolut perfektes Schreibgerät, dessen kompaktes, einteiliges Gehäuseelement direkt auf der Metallspitze aufliegt. Erhältlich in Silber, Kupfer, Schwarz oder Graphit, chromiert oder satiniert. Minimalismus, vereint mit unendlicher Variationsvielfalt: Das ist die harmonische Balance, die Prodir auszeichnet.

### DS8 avec embout métallique.

Le DS8 a toujours été l'un des produits les plus emblématiques et les plus appréciés de Prodir. Il est maintenant disponible avec un accessoire de luxe : l'embout métallique qui rehausse son corps triangulaire et, dans la version à agrafe métal, se combine élégamment avec l'agrafe et le poussoir. Un stylo absolument parfait où le corps, en un seul élément compact, est directement associé à l'embout. Disponible en argent, cuivre, noir ou graphite avec finition chrome ou satin. Un minimum d'éléments, une infinité de variations : c'est l'équilibre harmonieux trouvé par Prodir.

### DS8 con punta de metal.

El DS8, uno de los productos más icónicos y aclamados de Prodir, ya está disponible con punta metálica —un accesorio deluxe que resalta su cuerpo triangular— y, en la versión Metal Clip, armoniza con elegancia con el clip y el botón. El bolígrafo, que encarna la perfección absoluta, está formado por un único elemento compacto que reposa directamente en la punta. Disponible en plata, cobre, negro o grafito y con un acabado satinado o cromado. Una variedad infinita a partir de un número mínimo de elementos: un equilibrio armonioso con diseño único Prodir.

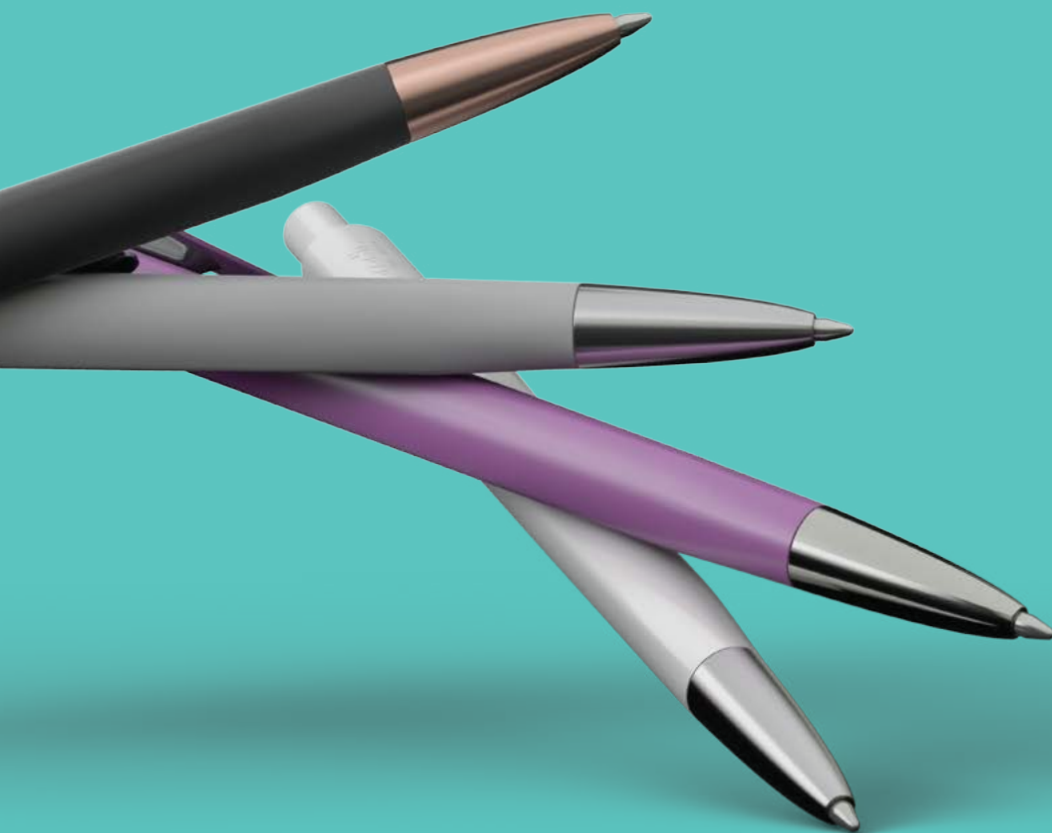
**DS8 con puntale in metallo.**

La DS8 è diventata sin da subito uno dei prodotti più iconici e amati della gamma Prodir. Da oggi si arricchisce di un prezioso dettaglio: il puntale in metallo che ne esalta il corpo triangolare e, nella versione Metal Clip, si abbina magistralmente a clip e pulsante. Una penna incredibilmente perfetta, il cui corpo, costituito da un unico elemento compatto, poggia direttamente sul puntale. Quattro le galvaniche disponibili: argento, rame, nero e grafite; nelle due varianti cromato o satinato. Pochi dettagli, una varietà infinita: è questo l'armonico equilibrio di casa Prodir.

**DS8 с конусным наконечником**

Ручка DS8 всегда являлась одним из самых популярных и любимых изделий Prodir. Теперь она выпускается в исполнении делюкс: с конусным металлическим наконечником, который подчеркивает треугольную форму корпуса, и металлическим зажимом, элегантно гармонирующим с кнопкой. Совершенная ручка, в которой корпус, состоящий из единственного компактного элемента, соединяется непосредственно с конусным наконечником. Выпускается в серебряном, медном, черном и графитовом цвете с хромированной или матовой отделкой. Минимальное количество элементов и бесконечное разнообразие – вот гармоничное сочетание, найденное компанией Prodir.

# QS04

## It's the hexagon that makes it.

A brand-new tactile experience, thanks to the 3D hexagonal pattern on the body of the new QS04.



**QS04.**  
**Die Wabenstruktur macht den Unterschied.**  
 Ein völlig neues taktiler Erlebnis bestimmt, dank der dreidimensionalen Wabenstruktur, die Gehäuseoberfläche des neuen QS04.

**QS04. C'est l'hexagone qui le fait.**  
 Une toute nouvelle expérience tactile avec le motif hexagonal 3D sur le corps du nouveau QS04.

**QS04. El hexágono marca la diferencia.**  
 Una experiencia táctil totalmente innovadora gracias al motivo hexagonal en relieve de la carcasa del nuevo QS04.

**QS04. L'esagono che fa la differenza.**  
 Un'esperienza tattile ancora inesplorata, grazie al modulo esagonale in 3D riprodotto sul corpo della nuova QS04.

**QS04. Все дело в шестиграннике**  
 Ранее не свойственное торговой марке тактильное ощущение создается благодаря трехмерному узору из шестигранников, который наносится на корпус новой ручки QS04.









The new DNA pen is the very latest development in promotional writing instruments. It is an extremely versatile product, designed for people who like to experiment and explore their own identity. Each and every detail perfectly reflects the brand and communicates its personality through multiple combinations. Because it's the details that make the difference.



The Promotional  
Gift Award Winner

**DEU** Der neue DNA Kugelschreiber repräsentiert die neueste Entwicklung unter den Werbeschreibgeräten. Dieses äußerst vielseitige Produkt wurde für Menschen entwickelt, die es mögen, mit der eigenen Identität zu experimentieren und ihr Wesen zu erforschen. Jedes einzelne Detail spiegelt die Werte der Marke perfekt wieder und kommuniziert über vielfältige Kombinationsvarianten zugleich deren Persönlichkeit. Denn der Unterschied steckt im Detail.

**FRA** Le nouveau stylo DNA est le tout dernier développement des instruments d'écriture promotionnels. Un produit extrêmement polyvalent, conçu pour les personnes qui aiment expérimenter et explorer leur propre identité. Chacun des détails reflète parfaitement la marque et

communique sa personnalité à travers de multiples combinaisons. Parce que ce sont les détails qui font la différence.

**ESP** El nuevo DNA es el último desarrollo en útiles de escritura. Un producto con una versatilidad extraordinaria, diseñado para personas innovadoras deseosas de experimentar y explorar su propia identidad. Todos y cada uno de sus elementos reflejan a la perfección la marca y comunican con claridad su personalidad gracias a un sinfín de combinaciones. Porque los detalles son los que marcan la diferencia.

**ITA** La nuova DNA raggiunge l'ultima frontiera degli strumenti di scrittura promozionali. È un prodotto estremamente versatile, progettato per chi

ama sperimentare e riscoprire una volta di più la propria identità. Ogni dettaglio racchiude la massima espressività del brand e ne comunica la personalità attraverso molteplici combinazioni. Perché sono i dettagli che fanno la differenza.

**CYR** Новая ручка DNA является новейшей разработкой среди рекламных канцелярских принадлежностей. Это необычайно многогранное изделие создано специально для тех, кто любит экспериментировать и исследовать собственную индивидуальность. Каждая деталь идеально выражает характерные черты вашей торговой марки и передает ее индивидуальность через разнообразные сочетания. Потому что именно детали решают все.



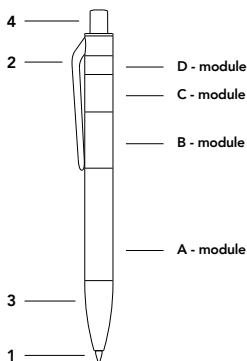

## product code

## 1 writing system

P Pushball pen

## 2 clip

P Polished

## 3 nose cone

P Polished

S Satin finish metal

C Chrome finish metal

## 4 button option

P Polished

S Satin finish metal

C Chrome finish metal

1	2	3		4
P	P	P	-	C

## print areas

## A A - module - matt

42 × 6 mm  
1,65" × 0,24"  
2 colours

## A - module - Soft Touch

1 colour\*\*

## A1 A - module - matt

38 × 6 mm  
1,50" × 0,24"  
6 colours

## A - module - Soft Touch

1 colour\*

## A2 A - module - matt

42 × 6 mm  
1,65" × 0,24"  
6 colours

## A - module - Soft Touch

1 colour\*

## B B - module - polished

19 × 6 mm  
0,75" × 0,24"  
2 colours

## B - module - metal

19 × 5 mm  
0,75" × 0,20"  
laser engraving

## B2 B - module - polished

19 × 6 mm  
0,75" × 0,24"  
6 colours

## B - module - metal

19 × 5 mm  
0,75" × 0,20"  
laser engraving

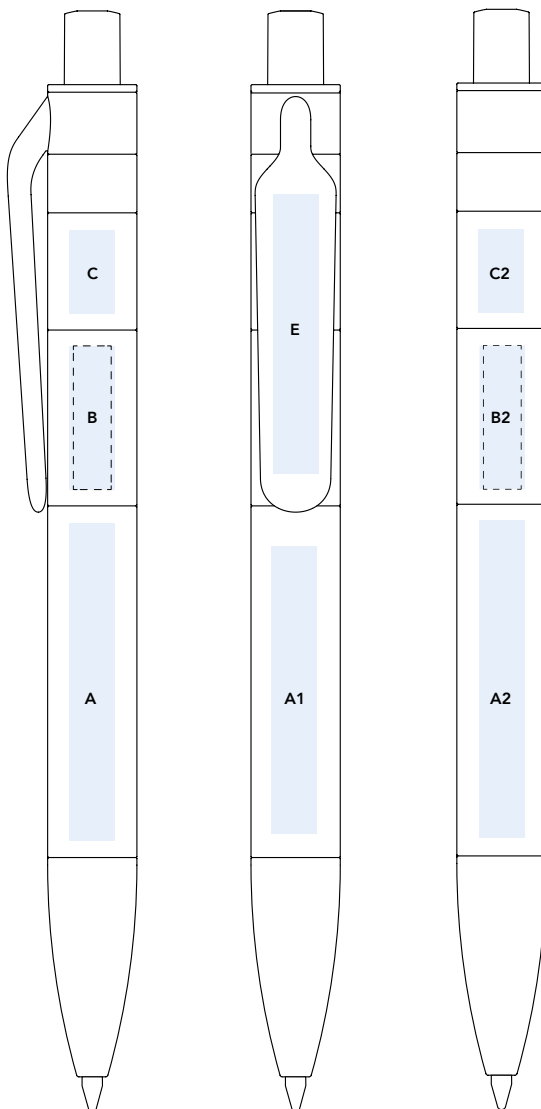

## C C - module - matt

11 × 6 mm  
0,43" × 0,24"  
2 colours

## C - module - Soft Touch

1 colour\*\*

## C2 C - module - matt

11 × 6 mm  
0,43" × 0,24"  
6 colours

## C - module - Soft Touch

1 colour\*

## E clip

37 × 7 mm  
1,46" × 0,28"  
6 colours

\*Black, white or silver.

Evaluated upon request:

- Printing up to 2 colours
- PMS

\*\* Black, white or silver

PMS evaluated upon request.

Standard Refill:  
Floating Ball® 1.0 mm.  
All Prodir pens are refillable.

**ENG****DNA**

The standard version consists of 4 modules (e.g. A + B + C + D) in any material, finish and colour. The modules can be placed on the pen as desired.

**DNA tailor-made (PZZ)**

Create your tailor-made DNA using from between 2 and 12 different modules, in any material, finish and colour (e.g. A + B + B). The modules can be placed on the pen as desired.

**A - module**

The pattern and Soft Touch pattern modules cannot be personalised.

The matt and Soft Touch modules can be personalised on the right and back sides, regardless of their position on the pen. The front can only be personalised if the module is adjacent to the nose cone.

**B - module**

The wooden module cannot be personalized.

The metal module can be personalized with laser engraving regardless of its position on the pen.

The polished module can be personalized on the right and back sides, regardless of its position on the pen. The front cannot be personalized.

**C - module**

The pattern and Soft Touch pattern modules cannot be personalized.

The matt and Soft Touch modules can be personalized on the right and back sides, regardless of their position on the pen. The front cannot be personalized.

**D - module**

This module cannot be personalized.

**wooden modules**

The colours of the wooden modules are purely indicative. Colour may vary due to the nature of the material and the unique grain of each piece.

**DEU****DNA**

Die Standardversion besteht aus vier Modulen (z.B. A + B + C + D) aus verschiedenen Materialien, Ausführungen und Farben. Die Module können beliebig auf dem Kugelschreiber positioniert werden.

**DNA tailor-made (PZZ)**

Sie können Ihre Massgeschneiderte DNA mit 2 bis zu 12 Modulen, aus verschiedenen Materialien, Ausführungen und Farben erstellen (z.B. A+B+B). Die Module können beliebig auf dem Kugelschreiber positioniert werden.

**Modul A**

Die Pattern und Pattern-Soft Touch Module sind nicht bedruckbar.

Die matten und Soft Touch Module sind, unabhängig von der Position, auf der rechten Seite und Hinterseite bedruckbar. Die Vorderseite ist nur dann bedruckbar, wenn das Modul neben der Spitze positioniert ist.

**Modul B**

Das Holzmodul ist nicht personalisierbar.

Das Metallmodul kann, unabhängig von der Position, mit einer Lasergravur personalisiert werden.

Das polierte Modul kann auf der rechten Seite und auf der Hinterseite, unabhängig von der Position, personalisiert werden. Die Vorderseite ist nicht personalisierbar.

**Modul C**

Die Pattern und Pattern-Soft Touch Module sind nicht bedruckbar.

Die matten und Soft Touch Module sind, unabhängig von der Position, auf der rechten Seite und Hinterseite bedruckbar. Die Vorderseite ist nicht bedruckbar.

**Modul D**

Dieses Modul ist nicht personalisierbar.

**Holzmodule**

Die abgebildeten Farben des Holzes sind rein indikativ. Angesichts der Einzigartigkeit des Materials und dessen Maserung könnte jedes Stück eine eigene Farbnuance haben.

**FRA****DNA**

La version standard est composée de 4 modules (A+B+C+D) de matériaux, finitions et couleurs différents. Les modules peuvent être placés librement.

**DNA tailor-made (PZZ)**

Vous pouvez créer votre DNA sur mesure en utilisant 2 à 12 modules différents, en choisissant le matériau, la finition et la couleur (par ex. A+B+B). Les modules peuvent être placés librement sur le stylo.

**Module A**

Les pattern modules et les pattern modules Soft Touch ne sont pas imprimables.

Les modules mats et Soft Touch sont imprimables sur la droite et sur les côtés quelle que soit la position sur le stylo. L'avant est imprimable que si le module est adjacent au embout.

**Module B**

Le module en bois n'est pas personnalisable.

Le module en métal est personnalisable en gravure laser quelle que soit la position sur le stylo.

Le module poli est imprimable sur le côté droit et à l'arrière, quelle que soit la position sur le stylo. L'avant est non imprimable.

**Module C**

Les pattern modules et les pattern modules Soft Touch ne sont pas imprimables.

Les module mats et Soft Touch sont imprimables sur le côté droit et à l'arrière, quelle que soit la position sur le stylo. L'avant est non imprimable.

**Module D**

Ce module est non imprimable.

**Modules bois**

Les couleurs des modules bois sont purement indicatives. Du au matériau et à la nature unique des nervures du bois, chaque pièce peut avoir sa couleur propre.

**ESP****DNA**

La versión estándar incluye 4 módulos (A+B+C+D) con materiales, acabados y colores diferentes. Los módulos pueden ser posicionados libremente en el bolígrafo.

**DNA Tailor-Made (PZZ)**

Puedes crear tu DNA Tailor-Made utilizando de 2 hasta 12 módulos de materiales, acabados y colores diferentes (por ejemplo, A+B+B). Los módulos pueden posicionarse libremente en el bolígrafo.

**Módulo A**

Los módulos pattern y pattern Soft Touch no son personalizables.

Los módulos mate y Soft Touch son personalizables sobre el lado derecho y en la parte trasera, independientemente de su posición en el bolígrafo. La parte delantera se puede personalizar solo si el módulo es adyacente al puntal.

**Módulo B**

El módulo de madera no es personalizable. El módulo de metal se puede personalizar con láser independientemente de su posición en el bolígrafo. La parte delantera no se puede personalizar.

**Módulo C**

Los módulos pattern y pattern Soft Touch no son personalizables.

Los módulos mate y Soft Touch se pueden personalizar sobre el lado derecho y sobre la parte trasera, independientemente de su posición en el bolígrafo. La parte delantera no se puede personalizar.

**Módulo D**

Este módulo no se puede personalizar.

**Modulos de madera**

Los colores que se muestran en los módulos de madera son puramente indicativos. Dada la naturaleza del material y la singularidad de sus vetas, cada pieza puede tener su propio matiz.

**ITA****DNA**

La versione standard è fornita con 4 moduli (A+B+C+D) di materiale, finitura e colore diversi. I moduli possono essere posizionati liberamente sulla penna.

**DNA tailor-made (PZZ)**

Puoi creare la tua DNA tailor-made utilizzando da 2 fino a 12 moduli di materiale, finitura e colore diversi (ad esempio A+B+B). I moduli possono essere posizionati liberamente sulla penna.

**Modulo A**

I moduli pattern e pattern Soft Touch non sono personalizzabili.

I moduli matt e Soft Touch sono personalizzabili sul lato destro e sul retro, indipendentemente dal loro posizionamento sulla penna. Il fronte è personalizzabile solo se il modulo è adiacente al puntale.

**Modulo B**

Il modulo in legno non è personalizzabile.

Il modulo in metallo è personalizzabile al laser indipendentemente dal suo posizionamento sulla penna. Il modulo polished è personalizzabile sul lato destro e sul retro, indipendentemente dal suo posizionamento sulla penna. Il fronte non è personalizzabile.

**Modulo C**

I moduli pattern e pattern Soft Touch non sono personalizzabili.

I moduli matt e Soft Touch sono personalizzabili sul lato destro e sul retro, indipendentemente dal loro posizionamento sulla penna. Il fronte non è personalizzabile.

**Modulo D**

Questo modulo non è personalizzabile.

**Moduli in legno**

I colori mostrati dei moduli in legno sono puramente indicativi. Data la natura del materiale e l'unicità delle sue venature ogni pezzo potrebbe avere una sua propria sfumatura.

**CYR****DNA**

Стандартная версия состоит из 4 частей (A + B + C + D) из разных материалов, покрытий и цвета. Составные части свободно комбинируются.

**DNA индивидуальной сборки (PZZ)**

Вы можете создать свою индивидуальную DNA, используя от 2 до 12 различных частей, из любого материала, покрытия и цвета (например, A + B + B). Составные части свободно комбинируются.

**Модуль A**

Нанесение на частях с объемным узором и с объемным узором «софт тач» невозможно.

Лазерная гравировка возможна на металлическом модуле независимо от его расположения.

Нанесение со стороны клипа возможно только на модуле прилегающем к носику.

**Модуль B**

На деревянном модуле нанесение невозможно.

Лазерная гравировка возможна на металлическом модуле независимо от его расположения.

Нанесение на полированной поверхности модуля возможно справа и сзади от клипа независимо от позиции модуля в ручке. Нанесение со стороны клипа невозможно.

**Модуль C**

Нанесение на частях с объемным узором и с объемным узором «софт тач» невозможно.

Нанесение на частях с матовым и «софт тач» покрытием возможно справа и сзади от клипа независимо от позиции модуля в ручке. Нанесение со стороны клипа невозможно.

**Модуль D**

Нанесение на модуле невозможно.

**Деревянные части**

Цвета, показанные для деревянных модулей, являются весьма приблизительными. Из-за природы материала и его уникальности каждая деталь может иметь другой оттенок.

## Small Box

The packaging for the new DNA is a detail that will not go unnoticed. A Small Box, made to measure, transparent and minimal in order to emphasise the personality of the object contained within and provide a glimpse of the chosen combination. Recyclable PET & Polypropylene. Not printable. Contains one DNA.

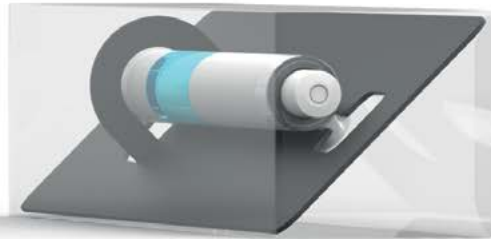

### Kleine Box

Die Verpackung des neuen DNA ist ein Detail, das nicht unbemerkt bleiben wird. Eine kleine Box, durchsichtig und minimal in ihrer Erscheinung, die die Persönlichkeit des darin enthaltenen Objekts betont und einen ersten Blick auf die gewählte Kombination ermöglicht.

Recyclingfähiges PET & Polypropylen.  
Nicht bedruckbar.  
Enthält ein DNA Schreibgerät.

### Petit coffret

L'emballage du nouveau DNA est un détail qui ne passe pas inaperçu. Un petit coffret sur mesure, transparente et minimaliste, qui met en valeur la personnalité de l'objet contenu et donne un aperçu de la combinaison choisie.

PET recyclable et polypropylène.  
Non imprimable.  
Contient un DNA.

### Small Box

El estuche del nuevo DNA es un detalle original que no pasará desapercibido. Una Small Box a medida — transparente y minimalista — diseñada para resaltar la personalidad del objeto que alberga dejando entrever la combinación elegida.

PET reciclable y polipropileno.  
No imprimible.  
Contiene un DNA.

### Small Box

La confezione della nuova DNA è un dettaglio che non passa inosservato. Uno Small Box disegnato su misura, trasparente ed essenziale, che esalta la personalità dell'oggetto che contiene e lascia intravedere la composizione scelta.

PET riciclabile e polipropilene.  
Non stampabile.  
Contiene una DNA.

### Небольшой чехол

Чехол для новой ручки DNA – это деталь, которая не останется незамеченной. Небольшой чехол, выполненный по индивидуальному заказу. Отличается прозрачностью и минимализмом в дизайне, призван подчеркнуть индивидуальность находящегося внутри предмета и создать мимолетное представление о выбранном для его изготовления сочетании.

ПЭТ-материал и полипропилен поддаются вторичной переработке. Печатные узоры отсутствуют. Предназначен для

**surfaces**

**P** Polished

**M** Matt

**R** Soft Touch

**PAT** Pattern

**W** Wood

**T** Transparent

**S** Satin finish metal

**C** Chrome finish metal

surfaces and colours

button



clip



D - module



C - module



B - module



A - module



nose cone



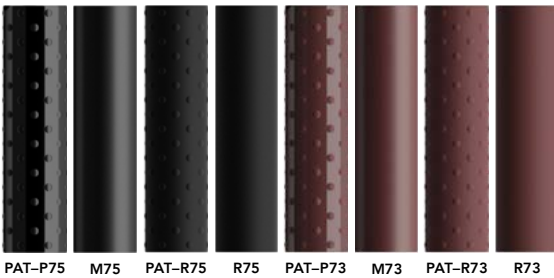
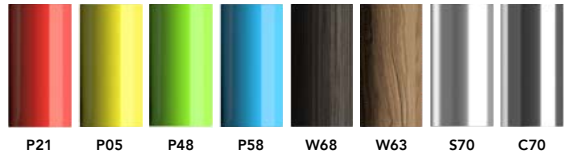
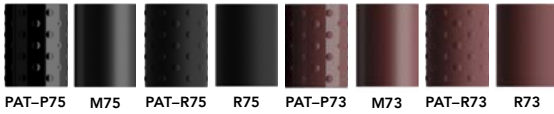
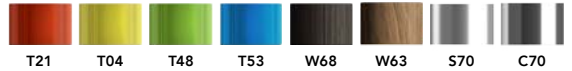



---

DNA PZZ



---

DNA PPC-C



---

DNA PPP-P



---

DNA PPP-P



---

DNA PPS-P



---

DNA PPP-P



The QS00 is the peak of personalisation. After in-depth exploration of the brand's communication potential, an ad-hoc print is created for the pattern on the pen. This is then used to produce a completely unique writing instrument, where your brand message and the pen body are intrinsically linked. The large print surface on the clip guarantees optimum visibility for your logo and is the perfect integration of brand and product. The QS00 body is available in matt, matt&polished and Soft Touch.



The Promotional  
Gift Award Winner



PromoFritz  
Award Winner

**DEU** Der QS00 spielt in Sachen Personalisierung in der obersten Liga. Nach einer eingehenden Analyse des Kommunikationspotentials der Marke wird für das Muster des Kugelschreibers eigens eine Druckvorlage erstellt. Diese wird dann verwendet, um ein vollkommen einzigartiges Schreibgerät zu erschaffen. Ihre Markenbotschaft und das Gehäuse des Kugelschreibers werden so untrennbar miteinander verbunden. Auf dem grossen bedruckbaren Clips kommt Ihr Logo bestmöglich zur Geltung, denn er ermöglicht ein perfektes Zusammenspiel zwischen dem Kugelschreiber und Ihrer Marke.

**FRA** Le QS00 est le sommet de la personnalisation. Après une étude approfondie du potentiel de communication de la marque, une impression ad hoc est créée pour le motif du stylo. Elle est ensuite utilisée pour produire un instrument d'écriture totalement unique, où votre message de marque et le corps du stylo sont intrinsèquement liés. La grande surface d'impression de l'agrafe assure une visibilité optimale pour votre logo et constitue une

intégration parfaite de la marque et du produit. Le corps du QS00 est disponible en mat, mat&poli et Soft Touch.

**ESP** El QS00 alcanza una personalización elevada a la máxima potencia. Tras estudiar a fondo el potencial de comunicación de la marca del cual será embajador, se crea una impresión específica para el motivo en relieve del bolígrafo. Con este motivo se fabrica un útil de escritura realmente único, en el que el mensaje de su marca y la carcasa del bolígrafo están intrínsecamente vinculados. El tamaño de la superficie de impresión del clip garantiza la máxima visibilidad para su logotipo y representa la integración perfecta entre marca y producto. La carcasa del QS00 está disponible en mate, mate & pulido y Soft Touch.

**ITA** La QS00 rappresenta il massimo della personalizzazione. Attraverso lo studio approfondito delle potenzialità comunicative del brand di cui diverrà ambasciatore, si arriva a creare uno stampo ad hoc che definisce il design del pattern e dà vita a uno strumento di scrittura

totalmente unico, in cui corpo e messaggio si legano in modo indissolubile. L'ampia superficie stampabile della clip garantisce un'ottima visibilità al brand e la perfetta integrazione tra marchio e prodotto. Il corpo della QS00 è disponibile in con finitura opaca, opaca&lucida e Soft Touch.

**CYR** Ручка QS00 – это верх индивидуализации. После глубокого изучения коммуникативного потенциала торговой марки для нанесения на эту ручку был специально разработан особый печатный узор. Таким образом создается уникальный инструмент для письма, органично связывающий воедино сообщение, которое несет в себе ваша торговая марка, и внешний вид ручки. На зажиме расположено пространство для печати, которое обеспечивает оптимальную заметность вашего логотипа, а также гармоничное соединение ручки и вашей торговой марки. Корпус ручки QS00 изготавливается с матовой, комбинированной матовой и полированной поверхностью или с мягкой поверхностью Soft Touch.



**product code**

**1 writing system**  
**P** Push ball pen

**2 body**  
**Z** Matt  
**Z** Matt +Polished  
**Z** Soft Touch

**3 clip & button**  
**Z** Transparent  
**Z** Polished

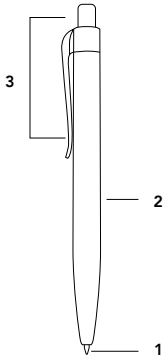

1	2	3
P	Z	Z

**print areas and personalised pattern**

**A clip**  
 36 × 7 mm  
 1,41" × 0,28"  
 6 colours

**B body**  
 personalised pattern

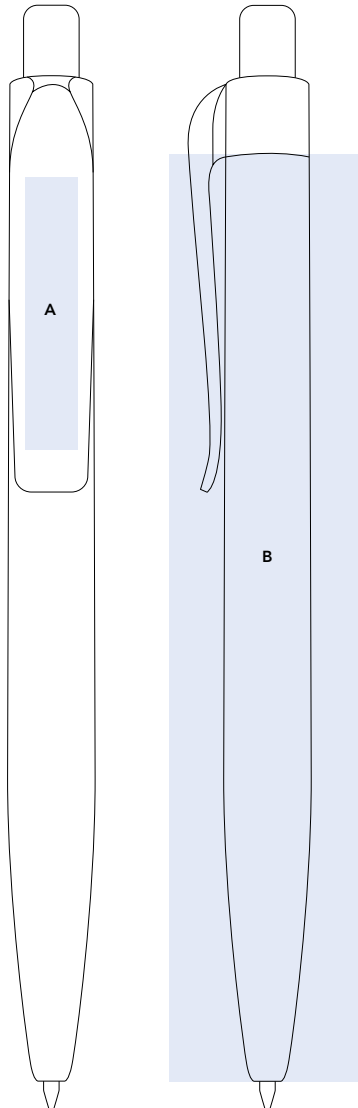

Standard refill:  
 Floating Ball® 1.0 mm.  
 Discover other options  
 on page 172.  
 All Prodir pens are refillable.

body surfaces  
and colours

Z - Matt



Z - Matt + Polished



Z - Soft Touch



clip & button  
surfaces  
and colours

Z - Transparent



Z - Polished



button option

S - Satin finish metal



S70

S02

S14

S75

S80

C - Chrome finish metal



C70

C02

C14

C75

C80



QS00 PZZ



QS00 PZZ



QS00 PZZ

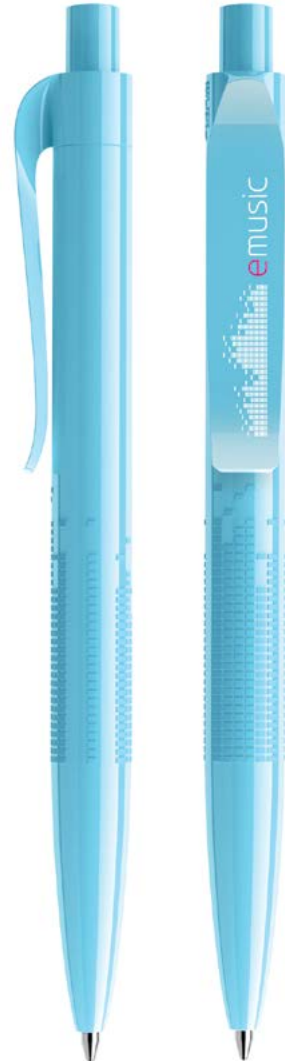
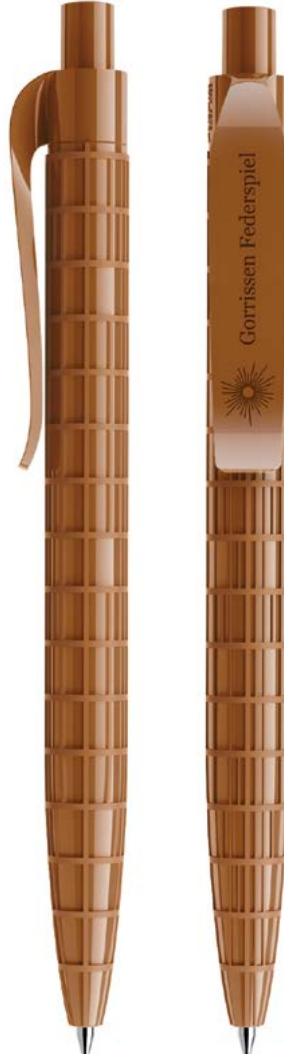



QS00 PZZ



QS00 PZZ



QS00 PZZ





The QS01 body boasts a 3D design made using special production techniques. The hypnotic triangular pattern repeats rhythmically over the surface of the pen. The elegant clip is smooth and slightly curved, guaranteeing maximum visibility for your logo. A play on form that catches the eye and demands to be touched, as well as a range of bright colours to satisfy all tastes. Also available with Soft Touch surfaces and a metal button available in 10 different finishes.



The Promotional  
Gift Award Winner

**DEU** Das Gehäuse des QS01 ist mit einem 3D-Muster veredelt, das mittels spezieller Techniken erzeugt wird. Das faszinierende Dreiecksmuster wiederholt sich rhythmisch auf der Oberfläche des Kugelschreibers. Der elegante, gebogene Clip hat eine gerade Druckfläche, um Ihr Logo bestmöglich zu präsentieren. Ein Formenspiel, das die Blicke auf sich zieht und ein Verlangen weckt, den Kugelschreiber in die Hand zu nehmen. Mit einer breiten Auswahl an kräftigen Farben kann er alle Geschmäcker zufriedenstellen. Er ist auch mit Soft-Touch-Oberfläche und einem Metallknopf erhältlich, für den zwischen 10 verschiedenen Oberflächenfinishes gewählt werden kann.

**FRA** Le corps du QS01 présente un design 3D réalisé avec une technique de fabrication spéciale. Le motif triangulaire hypnotique se répète de manière rythmée sur la surface du stylo. L'agrafe élégante, lisse et légèrement incurvée, donne une visibilité maximale à votre logo. Un jeu sur les formes qui capte le regard et invite à toucher, dans une gamme de couleurs vives afin de satisfaire tous les goûts. Egalement

disponible en surface soft touch avec bouton métal, en 10 finitions différentes.

**ESP** La carcasa del QS01 presenta un diseño tridimensional fabricado con técnicas de producción especiales. El hipnótico motivo triangular se repite rítmicamente por toda la superficie del bolígrafo. El elegante clip destaca por su silueta lisa y ligeramente curvada que garantiza la máxima visibilidad para su logotipo. Un auténtico juego de formas que se convierte en el foco de todas las miradas e insta a ser tocado, combinado con una amplia gama de colores brillantes para satisfacer todos los gustos. También está disponible con superficies Soft Touch y un botón metálico en 10 acabados distintos.

**ITA** Un disegno tridimensionale, ottenuto grazie a uno speciale processo produttivo, prende vita sul corpo della QS01. È un modulo ipnotico, triangolare, che si ripete ritmicamente sulla superficie della penna. La clip, levigata ed elegante, leggermente ricurva, garantisce la perfetta visibilità del logo. Un gioco di forme che incanta l'occhio e affascina il tatto, e una

gamma di colori accesi che incontra ogni gusto. Disponibile anche con superficie Soft Touch e pulsante in metallo in 10 diverse galvaniche.

**CYR** Корпус ручки QS01 отличается трехмерным дизайном, который изготавливается с применением специальной технологии. Завораживающий треугольный узор ритмически повторяется по всей поверхности ручки. Гладкий элегантный зажим слегка изогнут. Это обеспечивает максимальную заметность вашего логотипа. Игра формы притягивает глаз и вызывает желание прикоснуться, а широкий выбор ярких цветов удовлетворит любой вкус. Ручка также выпускается в исполнении с мягкой поверхностью Soft Touch. Для металлической кнопки предлагаются 10 различных вариантов отделки.

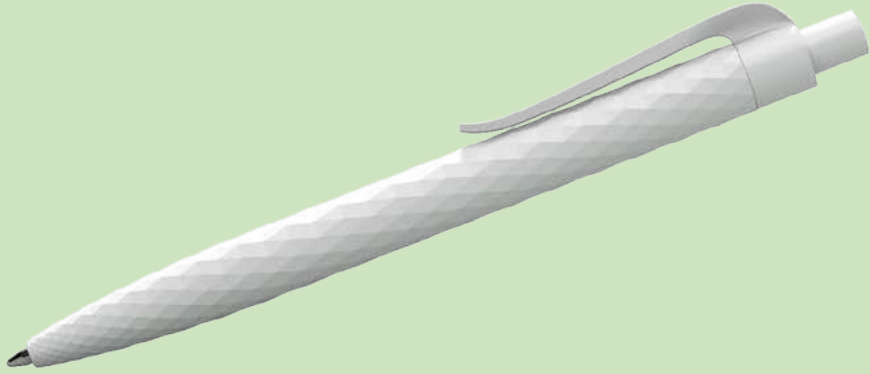

**product code**

**1 writing system**  
**P** Push ball pen

**2 body**  
**M** Matt  
**R** Soft Touch

**3 clip & button**  
**T** Transparent  
**P** Polished

**4 button option**  
**S** Satin finish metal  
**C** Chrome finish metal

1	2	3		4
P	M	T	-	S

**print areas**

**A clip**  
 36 × 7 mm  
 1,41" × 0,28"  
 6 colours

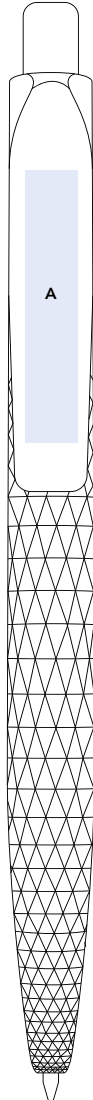

Standard refill:  
 Floating Ball® 1.0 mm.  
 Discover other options  
 on page 172.  
 All Prodir pens are refillable.

surfaces  
and colours

**M - Matt**



M02\*\* M05\*\* M09\* M29\*\* M20\* M62\* M58\* M67\* M66\* M77\*\* M75\*\*

**R - Soft Touch**



R05\*\* R09\* R29\*\* R20\* R62\* R58\* R67\* R66\* R77\*\* R75\*\*

- \* Standard with transparent clip & button
- \*\* Standard with polished clip & button

clip & button  
surfaces  
and colours

**T - Transparent**



T09 T20 T62 T53 T67 T66

**P - Polished**



P02 P05 P29 P77 P75

button option

**S - Satin finish metal**



S70 S02 S14 S75 S80

**C - Chrome finish metal**



C70 C02 C14 C75 C80



---

QS01 PMT



---

QS01 PMP



---

QS01 PMP



T53

M58

S70

P75

M66

P02

M02

QS01 PMT



QS01 PMP-S



QS01 PMP

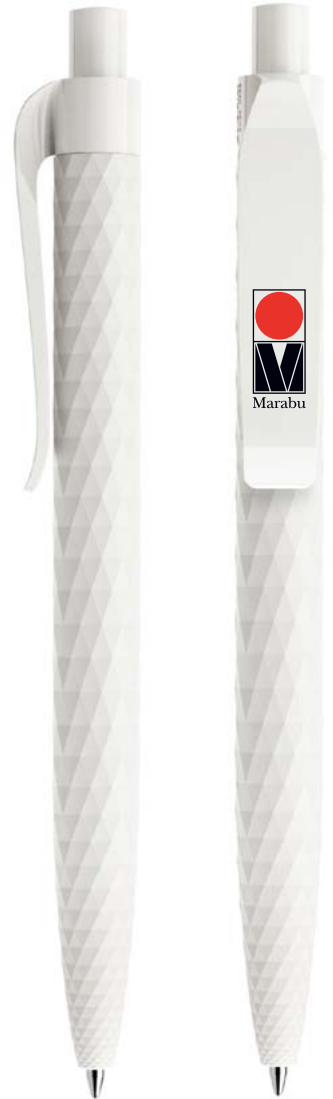

Soft Touch

P75

M75

T62

M62

T09

R09

QS01 PMP

QS01 PMT

QS01 PRT

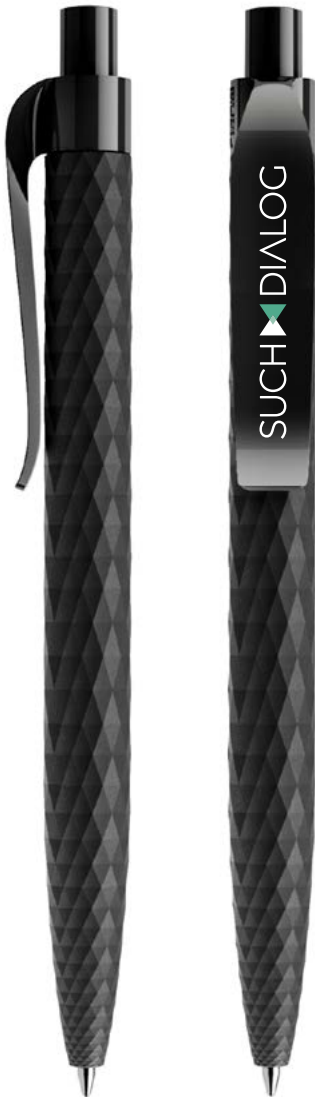

S70

T20

R20

S70

P02

R62

P75

R75

QS01 PRT-S



QS01 PRP-S

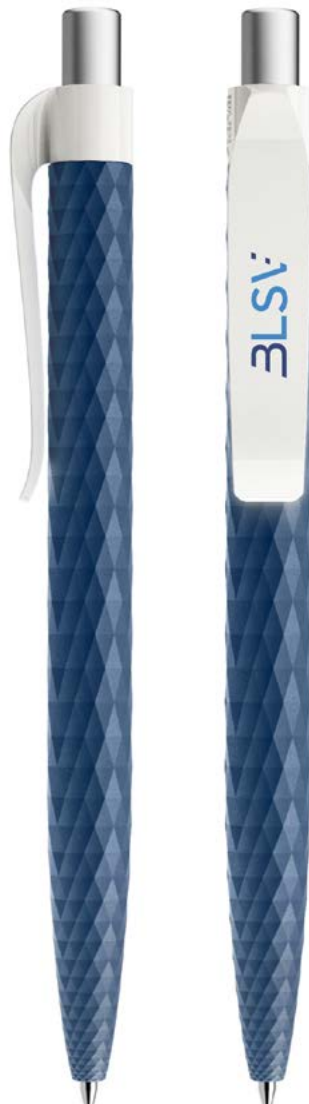

QS01 PRP





The perfect combination of product and message, the QS03 recalls a tyre both visually and physically, thanks to the 3D pattern on its surface. This product is aimed at a specialised market in the commercial vehicle sector, as a way to decisively and tangibly convey identity. The multisensorial attributes of this pen can be further enhanced with the Soft Touch surface. The metal button is available in 10 different finishes.

**DEU** Das perfekte Zusammenspiel von Produkt und Markenbotschaft. Dank des 3D-Musters auf seiner Oberfläche erinnert der QS03 nicht nur optisch an einen Reifen, er fühlt sich auch so an. Die Zielgruppe für dieses Produkt ist die Automobilbranche, in der durch den Kugelschreiber entschlossen und fühlbar Persönlichkeit vermittelt werden kann. Die Oberflächenmerkmale des Kugelschreibers, die mehrere Sinne ansprechen, können mithilfe einer Soft-Touch-Oberfläche sogar noch weiter hervorgehoben werden. Der Metallknopf ist in 10 verschiedenen Oberflächenfinishes erhältlich.

**FRA** Combinaison parfaite du produit et du message, le QS03 rappelle un pneu, visuellement et physiquement, grâce à la structure 3D de sa surface. Ce produit s'adresse à un marché spécialisé dans le secteur des véhicules utilitaires afin d'affirmer une identité de manière décisive et concrète. Les attributs multisensoriels de ce stylo peuvent être encore améliorés

avec la surface soft touch. Le poussoir métal est disponible en 10 finitions différentes.

**ESP** La combinación perfecta de producto y mensaje: el QS03 recuerda —tanto visual como físicamente— a un neumático gracias al motivo tridimensional de su superficie. El producto está diseñado para empresas del sector de vehículos comerciales y representa una forma única de transmitir de forma clara y palpable su identidad corporativa. Los atributos multisensoriales de este bolígrafo se pueden potenciar aún más con la superficie Soft Touch. El botón metálico está disponible en 10 acabados distintos.

**ITA** Combinazione perfetta tra prodotto e messaggio, la QS03 riproduce al tatto e alla vista le forme di uno pneumatico, grazie al pattern 3D che ne modella la superficie. È un prodotto destinato a un mercato specializzato, che si occupa di auto e veicoli commerciali, e intende comunicare la propria identità

in modo deciso e tangibile. L'esperienza multisensoriale può essere ulteriormente arricchita dalla finitura Soft Touch. Il pulsante in metallo è disponibile in 10 diverse galvaniche.

**CYR** Ручка QS03 – это идеальное сочетание изделия и заключенного в нем послания. Благодаря трехмерному узору, нанесенному на поверхность, внешний вид и тактильные ощущения вызывают ассоциации с шиной. Изделие специально предназначено для сегмента рынка автомобилей для грузовых и пассажирских перевозок. Оно призвано решительно и осязаемо передавать индивидуальность. Различные элементы ручки изготавливаются из разных на ощупь материалов. Мультисенсорное впечатление можно дополнительно разнообразить за счет использования мягкой поверхности Soft Touch. Для металлической кнопки предлагаются 10 различных вариантов отделки.

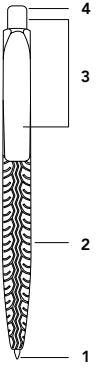

**product code**

**1 writing system**  
**P** Push ball pen

**2 body**  
**M** Matt  
**R** Soft Touch

**3 clip & button**  
**T** Transparent  
**P** Polished

**4 button option**  
**S** Satin finish metal  
**C** Chrome finish metal

1	2	3		4
P	M	T	-	S

**print areas**

**A clip**  
 36 × 7 mm  
 1,41" × 0,28"  
 6 colours



Standard refill:  
 Floating Ball® 1.0 mm.  
 Discover other options  
 on page 172.  
 All Prodir pens are refillable.

surfaces  
and colours

**M - Matt**



M75

**R - Soft Touch**



R75

clip & button  
surfaces and  
colours

**T - Transparent**

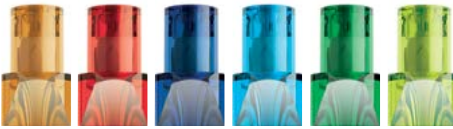

T09

T20

T62

T53

T67

T66

**P - Polished**



P02

P05

P29

P77

P75

button option

**S - Satin finish metal**



S70

S02

S14

S75

S80

**C - Chrome finish metal**



C70

C02

C14

C75

C80

P02

M75

P75

M75

P75

M75

QS03 PMP

QS03 PMP

QS03 PMP



S70

P75

M75

P02

M75

T62

M75

QS03 PMP-S



QS03 PMP



QS03 PMT



Soft Touch

S70

P75

R75

C70

P75

R75

C70

P05

R75

QS03 PRP-S

QS03 PRP-C

QS03 PRP-C

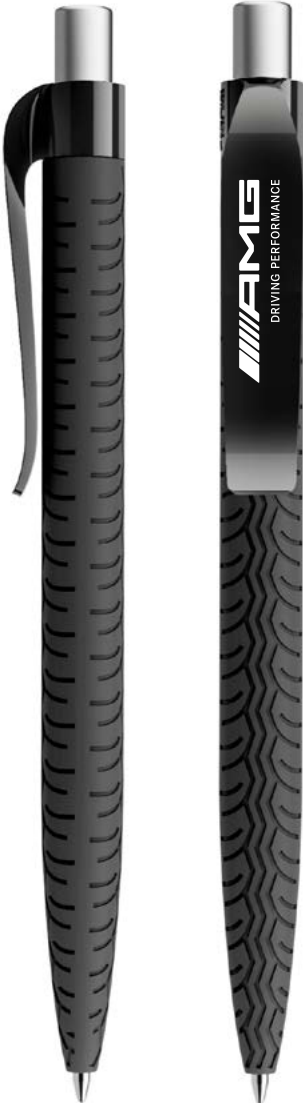

P75

R75

S70

P02

R75

T67

R75

QS03 PRP

QS03 PRP-S

QS03 PRT





An iconic and compact body with a 3D honeycomb surface for a tactile experience, whether in polished or Soft Touch. The minimal clip contrasts with the pattern and enhances the visibility of your logo. The QS04 is a refined and harmonious product, with a memorable identity transmitted through both sight and touch. The hexagon is the detail that makes the difference, making your message even more recognisable and authentic. The metal button is available in 10 different finishes.

**DEU** Das ikonische, kompakte Gehäuse mit einer 3D-Honigwabenoberfläche für ein einzigartiges Tasterlebnis, egal ob poliert oder in Soft-Touch-Ausführung. Der minimalistische Clip schafft einen Kontrast zum Muster und erhöht so die Sichtbarkeit Ihres Logos. Der QS04 ist ein anspruchsvolles und harmonisches Produkt mit einem unvergesslichen Charakter, der sowohl optisch als auch haptisch vermittelt wird. Das Wabenmuster macht den Unterschied und verleiht Ihrer Markenbotschaft mehr Wiedererkennungswert und Authentizität. Der Metallknopf ist in 10 verschiedenen Oberflächenfinishes erhältlich.

**FRA** Un corps de stylo emblématique et compact avec une surface 3D en nid d'abeilles pour une expérience tactile, en poli ou en soft touch. L'agrafe minimaliste contraste avec le motif et améliore la visibilité de votre logo. Le QS04 est un produit raffiné et harmonieux, avec une identité marquante, transmise par la vue et le toucher. L'hexagone est le détail qui fait la différence, rendant votre message encore

plus reconnaissable et authentique. Le poussoir métal est disponible en 10 finitions différentes.

**ESP** La carcasa compacta e icónica con superficie tridimensional de panal de miel brinda una única experiencia táctil, en pulido o Soft Touch. El clip minimalista contrasta con el motivo en relieve y realza su logotipo. El QS04 es un producto que, con elegancia y armonía, transmite una identidad inolvidable que se percibe con la vista y con el tacto. El motivo hexagonal es el detalle que marca la diferencia y garantiza que su mensaje sea aún más fácil de reconocer y más auténtico. El botón metálico está disponible en 10 acabados distintos.

**ITA** Un corpo iconico e compatto, la cui superficie riproduce una struttura 3D a nido d'ape e permette l'esperienza tattile, sia in versione lucida che Soft Touch, di uno schema ancora inesplorato. Il minimalismo della clip contrasta con il pattern modulare e favorisce la visibilità del logo. La QS04 è un prodotto raffinato e armonico, con

un'identità memorabile al tatto e alla vista. L'esagono diventa il dettaglio che fa la differenza nel comunicare e rende il messaggio ancora più riconoscibile e autentico. Il pulsante in metallo è disponibile in 10 diverse galvaniche.

**CYR** Стильный и компактный корпус с трехмерным узором в виде пчелиных сот создает приятные тактильные ощущения в любом исполнении: с полированной или мягкой поверхностью Soft Touch. Минималистичный дизайн зажима контрастирует с узором и способствует заметности вашего логотипа. Ручка QS04 – утонченное и гармоничное изделие, незабываемая индивидуальность которого передается как внешним видом, так и тактильными ощущениями. Шестиграннык – это тот элемент, который акцентирует индивидуальность и делает ваше сообщение еще более узнаваемым и аутентичным. Для металлической кнопки предлагаются 10 различных вариантов отделки.

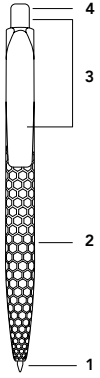

**product code**

**1 writing system**  
**P** Push ball pen

**2 body**  
**M** Matt  
**R** Soft Touch

**3 clip & button**  
**T** Transparent  
**P** Polished

**4 button option**  
**S** Satin finish metal  
**C** Chrome finish metal

1	2	3		4
P	M	T	-	S

**print areas**

**A clip**  
 36 x 7 mm  
 1,41" x 0,28"  
 6 colours

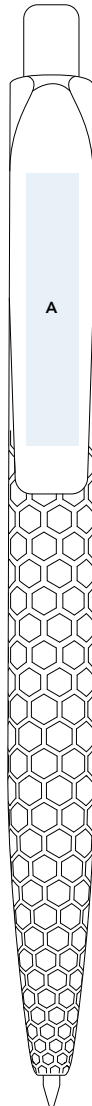

Standard refill:  
 Floating Ball® 1.0 mm.  
 Discover other options  
 on page 172.  
 All Prodir pens are refillable.

surfaces  
and colours

**P - Polished**

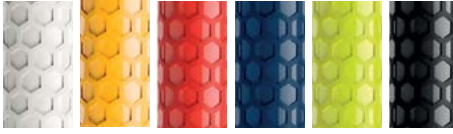

P02\*\* P16\* P20\* P62\* P66\* P75\*\*

**R - Soft Touch**



R16\* R20\* R62\* R66\* R75\*\*

- \* Standard with transparent clip & button
- \*\* Standard with polished clip & button

clip and button  
surfaces and  
colours

**T - Transparent**



T16 T20 T62 T66

**P - Polished**



P02 P75

button option

**S - Satin finish metal**



S70 S02 S14 S75 S80

**C - Chrome finish metal**



C70 C02 C14 C75 C80



---

QS04 PPT

---

QS04 PPT

---

QS04 PPP

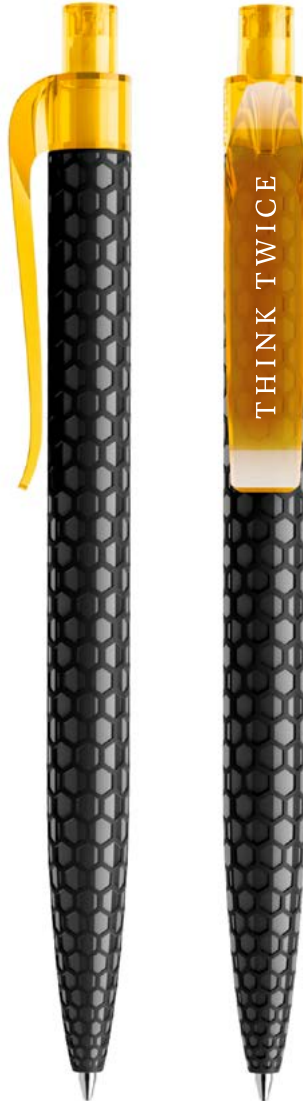

P02

C70

P75

P66

C70

P02

P62

QS04 PPP



QS04 PPP-C



QS04 PPP-C



Soft Touch

T66

R66

P75

R75

S70

P75

R75

QS04 PRT



QS04 PRP



QS04 PRP-S



T62

R62

S70

T20

R20

T16

R16

QS04 PRT

QS04 PRT-S

QS04 PRT





A smooth minimal clip sits on a sculpted and decisive body. The QS20 takes the concept of 3D design to the extreme, exhibiting its potential on its shaped body. A well-balanced product with a definite style that will not go unnoticed. Ideal for underlining your brand's identity and originality with strength and determination. Here function is enhanced by 11 different colour options and countless Mix & Match combinations. The matt and Soft Touch versions enrich the multisensorial experience, which is refined even further with metal buttons, available in 10 different finishes.



The Promotional  
Gift Award Winner

**DEU** Auf einem kantigen Gehäuse thront ein glatter, minimalistischer Clip. Der QS20 geht mit dem Konzept des 3D-Designs bis ans Äußerste und in seinem kantigen Gehäuse spiegelt sich sein ganzes Potential. Ein ausgewogenes Produkt mit einem unverkennbaren, unübersehbaren Stil. Ideal, um die Identität und die Einzigartigkeit Ihrer Marke kraftvoll und bestimmt hervorzuheben. 11 verschiedene Farboptionen und unzählige Kombinationsmöglichkeiten unterstreichen seinen Charakter. Die matte als auch die Soft-Touch-Ausführung des QS20 sind ein Erlebnis für die Sinne. Dieses Erlebnis wird durch den in 10 verschiedenen Ausführungen erhältlichen Metallknopf noch verstärkt.

**FRA** L'agrafe lisse et minimaliste se détache du corps de stylo à l'apparence marquante, au caractère de sculpture. Le QS20 pousse le concept du design 3D à l'extrême, en exposant son potentiel sur son corps façonné. Un produit bien équilibré avec un style précis, qui ne passera pas inaperçu. Idéal pour souligner l'identité et l'originalité de votre marque avec force et détermination. Sa fonction est soulignée par 11 couleurs différentes et d'innombrables combinaisons Mix&Match. Les versions mat et soft touch enrichissent

l'expérience multisensorielle, encore plus raffinée avec des poussoirs métal, disponibles en 10 finitions différentes.

**ESP** Un clip minimalista liso destaca ante una carcasa esculpida y con fuerte personalidad. El QS20 lleva al extremo el concepto del diseño tridimensional, desvelando todo su potencial en su carcasa modelada. Un producto armonizado con un estilo definido que no pasará desapercibido. Ideal para resaltar la identidad y originalidad de su marca con firmeza y determinación. Esta misión se potencia aún más con 11 opciones distintas de color e infinitas combinaciones Mix&Match. Las versiones mate y Soft Touch intensifican la experiencia multisensorial, que se desarrolla aún más con botones metálicos, disponibles en 10 acabados distintos.

**ITA** Una clip levigata e minimale poggia su un corpo scolpito e deciso. La QS20 porta il concetto di design tridimensionale all'estremo, esibendone le potenzialità sul corpo scolpito. Un prodotto equilibrato, dallo stile deciso, che non passa inosservato, adatto a ribadire con forza e determinazione l'identità e l'originalità del brand. 11 colori e innumerevoli combinazioni Mix&Match ne garantiscono la

funzionalità. Le versioni opaca e Soft Touch arricchiscono l'esperienza multisensoriale che si fa ancora più raffinata grazie ai pulsanti in metallo, disponibili in 10 diverse galvaniche.

**CYR** Гладкий минималистичный зажим помещается на корпусе, который имеет завершённую и отточенную скульптурную форму. В ручке QS20 концепция трехмерного дизайна доводится до предела и демонстрирует весь свой потенциал в сложной форме корпуса. Это гармоничное изделие, четко выраженный стиль которого не останется незамеченным. Идеально подходит для того, чтобы с силой и определенностью подчеркнуть идентичность и оригинальность вашей торговой марки. Его усовершенствованная функциональность позволяет использовать 11 различных цветовых вариантов, а также бесчисленные сочетания по выбору. Исполнение с матовой поверхностью или мягкой поверхностью Soft Touch обогащает мультисенсорное впечатление, утонченность которого дополнительно подчеркивается металлическими кнопками, для которых предлагаются 10 различных вариантов отделки.



**product code**

**1 writing system**  
**P** Push ball pen

**2 body**  
**M** Matt  
**R** Soft Touch

**3 clip & button**  
**T** Transparent  
**P** Polished

**4 button option**  
**S** Satin finish metal  
**C** Chrome finish metal

1	2	3		4
P	M	T	-	S

**print areas**

**A clip**  
 36 × 7 mm  
 1,41" × 0,28"  
 6 colours

**B barrel**  
 3 × 18 mm  
 0,11" × 0,70"  
 1 colour available  
 only with matt  
 surface



Standard refill:  
 Floating Ball® 1.0 mm.  
 Discover other options on  
 page 172.  
 All Prodir pens are refillable.

surfaces  
and colours

**M - Matt**



M02\*\* M05\*\* M09\* M29\*\* M20\* M62\* M58\* M67\* M66\* M77\*\* M75\*\*

**R - Soft Touch**



R05\*\* R09\* R29\*\* R20\* R62\* R58\* R67\* R66\* R77\*\* R75\*\*

- \* Standard with transparent clip & button
- \*\* Standard with polished clip & button

clip & button  
surfaces  
and colours

**T - Transparent**



T09 T20 T62 T53 T67 T66

**P - Polished**



P02 P05 P29 P77 P75

button option

**S - Satin finish metal**



S70 S02 S14 S75 S80

**C - Chrome finish metal**



C70 C02 C14 C75 C80



QS20 PMT

QS20 PMP-S

QS20 PMT

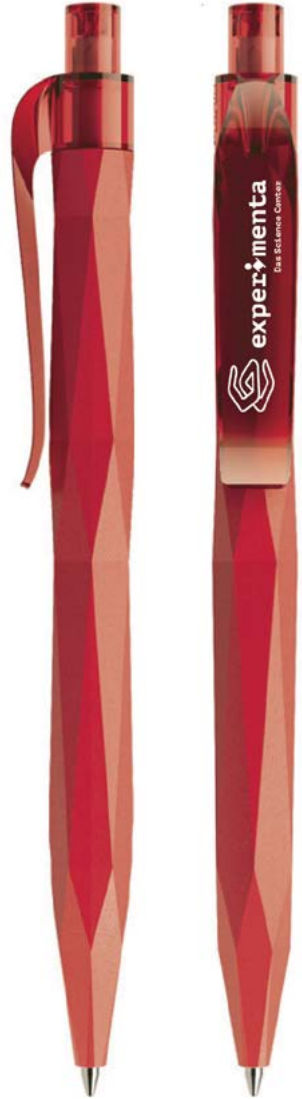
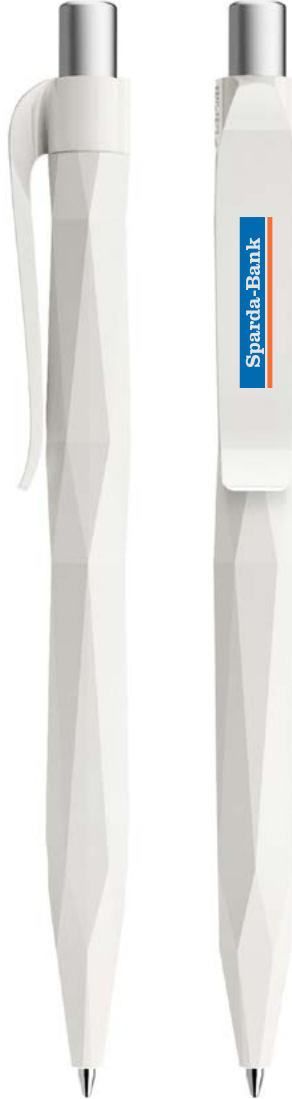
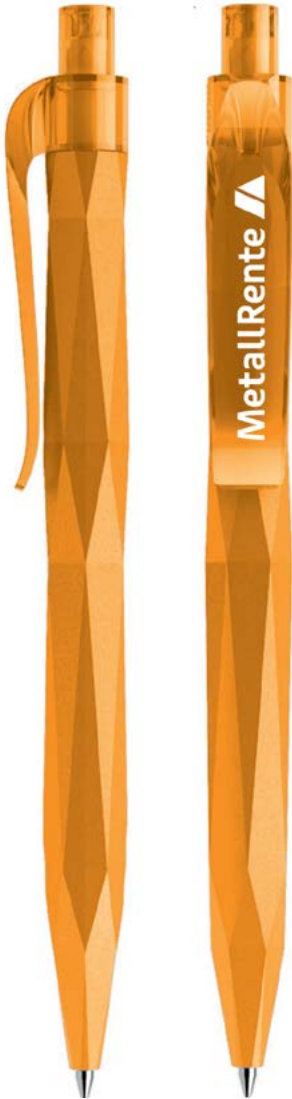

P05

M05

T67

M67

P75

M66

---

QS20 PMP

---

QS20 PMT

---

QS20 PMP

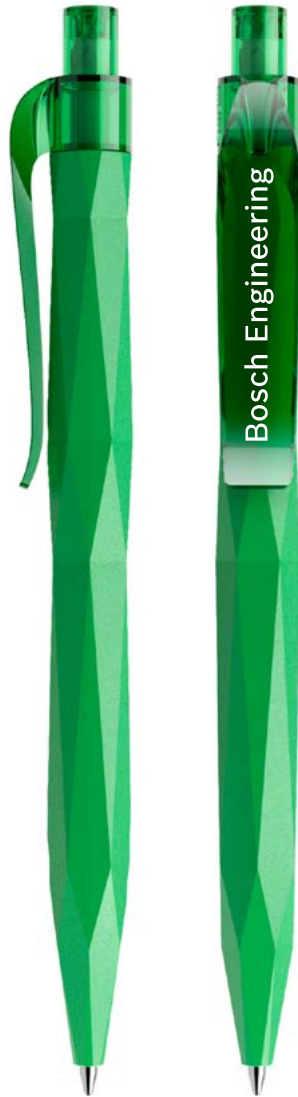
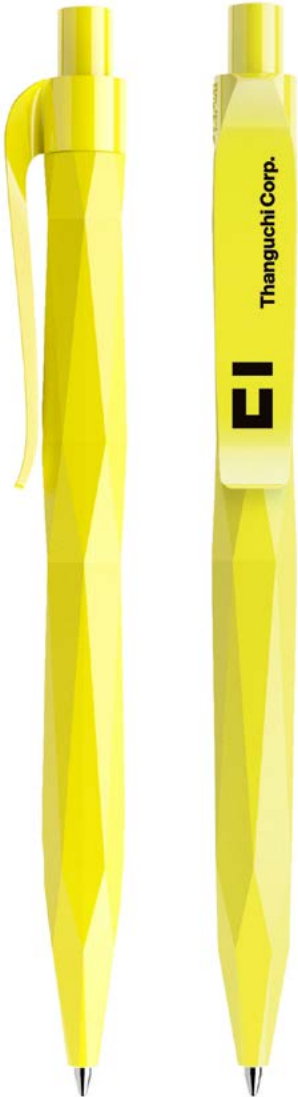

Soft Touch

S70

T53

R58

T20

T62

R62

P02

R20

QS20 PRT-S

QS20 PRT

QS20 PRP

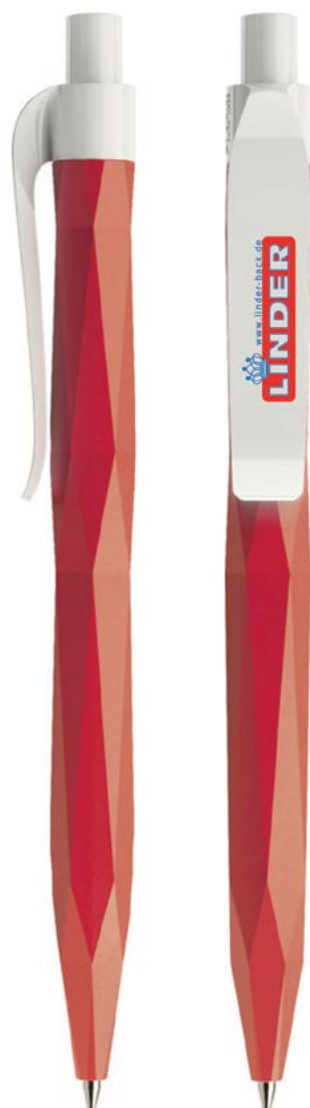
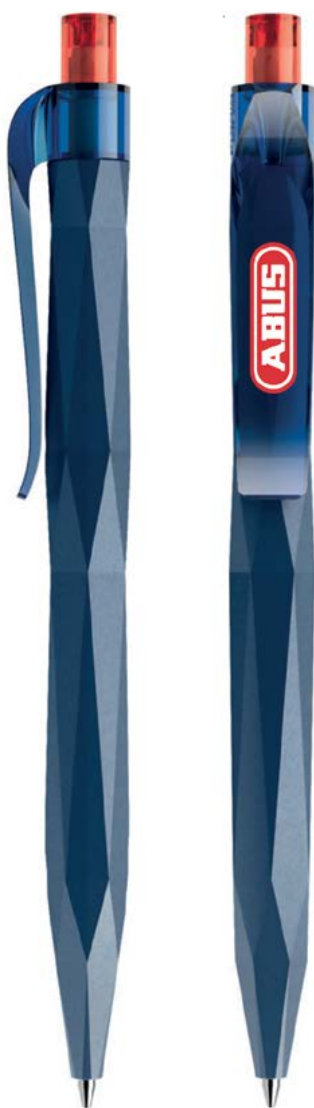
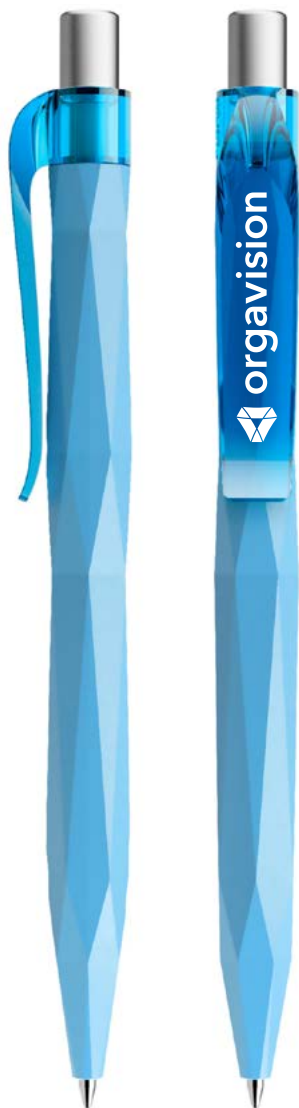

C70

P75

R75

P77

R77

C70

T66

R66

QS20 PRP-C

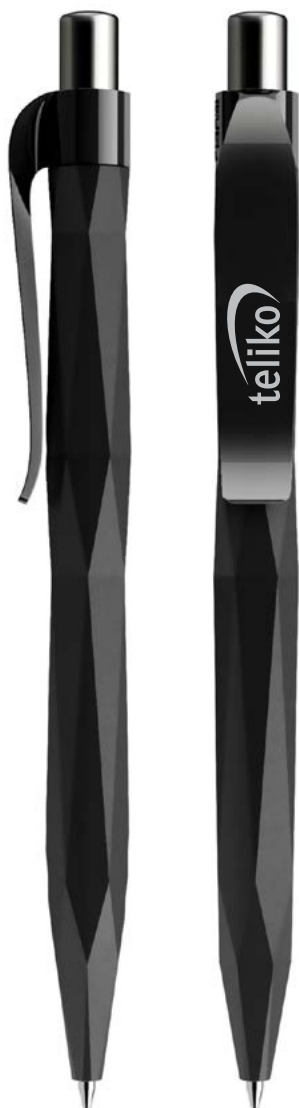

QS20 PRP

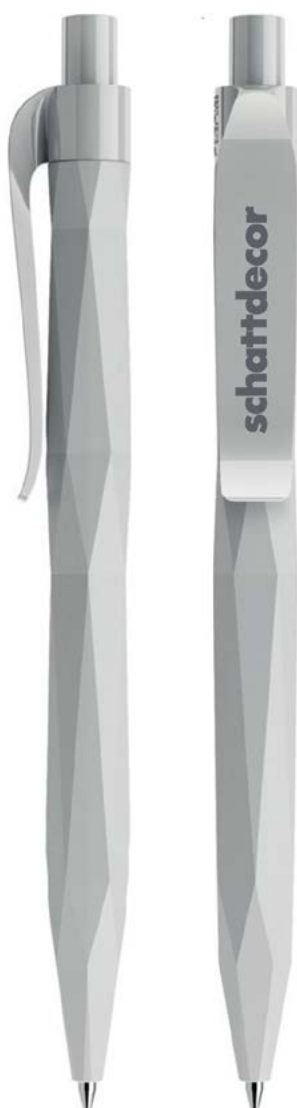

QS20 PRT-C

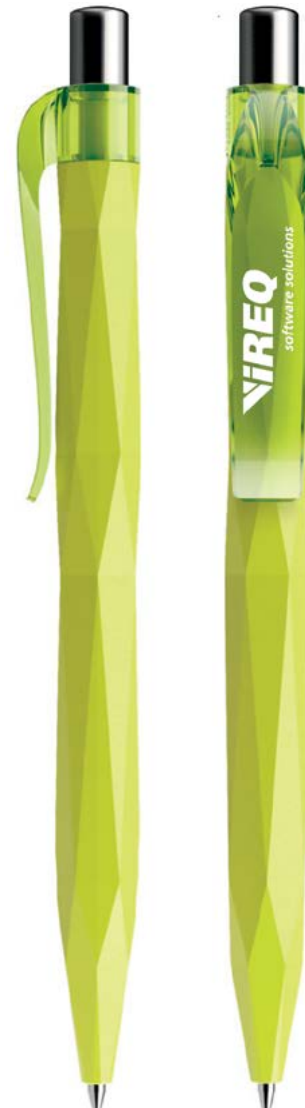



A classic writing instrument design. Its slender body and curved cap give the DS1 a sinuous and dynamic shape. It boasts different print surfaces: cap back and side, body, clip and dot. It can be printed on both sides and is available in 12 colours, the dot adds a dash of originality to a linear design which is memorable in its sheer simplicity.

**DEU** Ein klassisches Schreibgerätedesign. Sein schlankes Gehäuse und die abgerundete Kappe verleihen dem DS1 eine schwungvolle und dynamische Form. Viele verschiedene Oberflächen des DS1 sind bedruckbar: die Kappe hinten und seitlich, das Gehäuse, der Clip und der Kappenpunkt. Er kann auch beidseitig bedruckt werden und ist in 12 Farben erhältlich. Der Kappenpunkt verleiht dem linearen Design, das durch seine Einfachheit im Gedächtnis bleibt, eine gewisse Einzigartigkeit.

**FRA** Un instrument d'écriture au design classique. La ligne élancée du corps de stylo et le capuchon incurvé confèrent au DS1 une forme sinieuse et dynamique. Il propose surfaces d'impression différentes capuchon, corps du stylo, agrafe et la distinctive pastille d'agrafe. Il peut être imprimé des deux côtés, il est disponible

dans 12 couleurs, la pastille d'agrafe ajoute une touche originale au design linéaire qui est mémorable dans sa simplicité.

**ESP** Un útil de escritura de diseño clásico. Su carcasa estilizada y su capuchón curvado confieren al DS1 una silueta dinámica y sinuosa. Ofrece varias superficies imprimibles: capuchón, carcasa, clip y ambas superficies del distintivo punto del capuchón. El punto del capuchón está disponible en 12 colores y confiere un toque original a un diseño lineal fácil de recordar por su sobria sencillez.

**ITA** Un classico nel design degli strumenti di scrittura. Con il suo corpo slanciato e il cappuccio ricurvo, la DS1 vanta una linea sinuosa e dinamica. A ciò si aggiungono differenti aree di marcatura: dal cappuccio al corpo, dalla clip al caratteristico nottolino. Stampabile su

entrambi i lati e disponibile in 12 colori, il nottolino aggiunge un tocco di originalità a un design lineare, memorabile nella sua semplicità.

**CYR** Классический дизайн инструмента для письма. Тонкий корпус и изогнутый колпачок придают ручке DS1 изогнутую и динамичную форму. На ней имеются разные поверхности для печати: на задней и боковой поверхностях колпачка, на корпусе, на зажиме и на круглом элементе. Круглый элемент предлагается в одном из 12 вариантов цветового исполнения, печать может наноситься на обе стороны. Это – штрих индивидуальности в линейном дизайне, который запоминается своей абсолютной простотой.

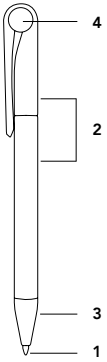

**product code**

**1 writing system**  
T Twist ball pen

**2 surface**  
F Frosted  
T Transparent  
M Matt  
P Polished

**3 nose cone**  
F Frosted  
T Transparent  
M Matt  
P Polished  
S Satin finish metal  
C Chrome finish metal

**4 option**  
X Dot

1	2	3		4
T	F	S	-	X

**print areas**

**A side cap**  
18 × 4 mm  
0,71" × 0,16"  
1 colour

**B dot**  
8 × 8 mm  
0,31" × 0,31"  
5 colours

**C1 clip**  
35 × 7 mm  
1,38" × 0,28"  
5 colours

**C2 clip**  
40 × 5 mm  
1,57" × 0,20"  
5 colours

**D back cap**  
23 × 4 mm  
0,90" × 0,16"  
1 colour

**E body**  
50 × 25 mm  
1,97" × 0,98"  
4 colours

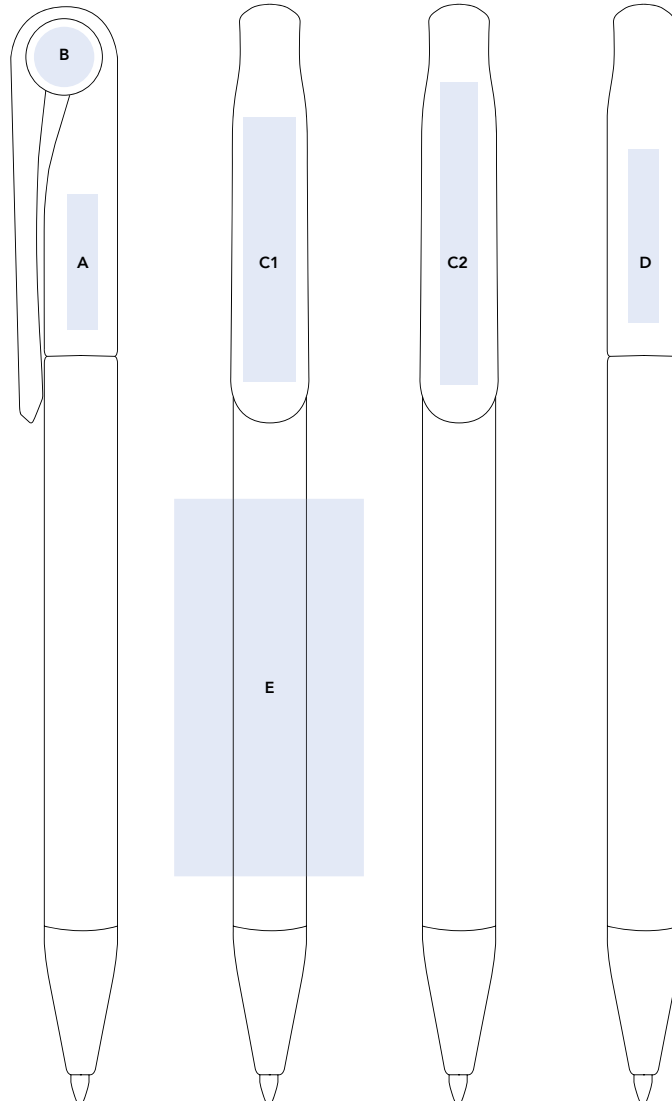

Standard refill:  
Floating Ball® 1.0 mm.  
Discover other options  
on page 172.  
All Prodir pens are refillable.

surfaces  
and colours

**F - Frosted**

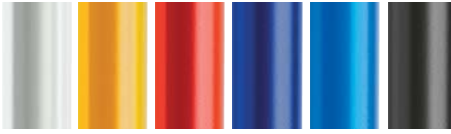

F01 F06 F20 F50 F55 F75

**T - Transparent**

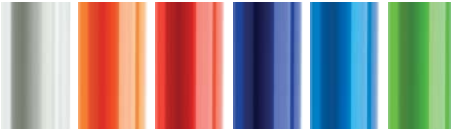

T01 T10 T20 T50 T55 T47

**M - Matt**



M02 M23 M49 M70 M75

**P - Polished**



P02 P06 P10 P52 P58 P75

dot option  
surfaces  
and colours

**X - Polished**



X01 X06 X10 X20 X23 X52 X55 X58 X47 X49 X70 X75

nose cone  
option

**S - Satin finish metal**



**C - Chrome finish metal**





---

DS1 TFF-X

---

DS1 TFF-X

---

DS1 TFF-X



Transparent

T10

DS1 TTC



T47

DS1 TTT



X01

T50

DS1 TTC-X



Matt



DS1 TMM-X



DS1 TMS



DS1 TMM-X



Polished

P06

X01

X20

P58

P75

DS1 TPP

DS1 TPP-X

DS1 TPC-X





Ergonomic and compact, the DS2 is a pen with character that will not be easily forgotten. It offers multiple options for personalisation: 5 different print areas and an elongated button, which can be engraved. The button is without a doubt the detail that makes the DS2 stand out. It is available in a wider colour range than any other Prodir pen, as well as in all 4 finishes: frosted, transparent, matt and polished. For a guaranteed aesthetic result and a highly personalised product.



The Promotional  
Gift Award Winner

**DEU** Ergonomisch und kompakt. Der DS2 ist ein Kugelschreiber mit Charakter, der einen bleibenden Eindruck hinterlässt. Er bietet eine Vielzahl an Möglichkeiten zur Personalisierung: 5 verschiedene Druckbereiche und ein langer Clip, der mittels Lasergravur bearbeitet werden kann. Seine Farbpalette ist breiter als die jedes anderen Kugelschreibers von Prodir. Der DS2 ist außerdem in allen 4 Oberflächenfinishes erhältlich: gefrostet, transparent, matt und poliert. Für ein garantiert ästhetisches Ergebnis und ein hochgradig personalisiertes Produkt.

**FRA** Ergonomique et compact, le DS2 est un stylo dont le caractère ne s'oublie pas facilement. Il offre de multiples options pour sa personnalisation : 5 zones d'impression différentes et un poussoir allongé, qui peut être personnalisé avec gravure laser. Le poussoir est sans aucun doute le détail qui distingue la DS2. Il est disponible dans une gamme de couleurs

plus large que tous les autres stylos Prodir, ainsi que dans toutes les 4 finitions : givré, transparent, mat et poli.

**ESP** Ergonómico y compacto, el DS2 es un bolígrafo con carácter que será difícil de olvidar. Ofrece distintas opciones de personalización: cinco áreas distintas de impresión y un botón alargado, que se puede grabar con láser. Gracias al detalle de su original botón, el DS2 destaca siempre. Es posible elegir entre una gama de colores más amplia que otros bolígrafos Prodir, así como entre 4 acabados: hielo, transparente, mate y pulido.

**ITA** Ergonomica e compatta, la DS2 è una penna di carattere, che resta impressa nella memoria. Le possibilità di personalizzazione sono molteplici: 5 differenti aree di marcatura e un pulsante allungato, su cui è possibile effettuare incisioni laser. Nella DS2, il pulsante è senza dubbio il dettaglio che fa la differenza.

Dispone di una gamma colori molto più ricca di ogni altro dettaglio Prodir, ed è realizzabile in tutte e 4 le finiture: satinata, trasparente, opaca e lucida.

**CYR** Эргономичная и компактная ручка DS2 отличается характером, который нелегко забыть. Она предлагает большое количество возможностей для индивидуализации: 5 различных участков для печати и удлиненная кнопка, на которой может выполняться лазерная гравировка. Без сомнения, именно кнопка является тем элементом, который делает ручку DS2 непохожей на другие. Для данного изделия предлагается самый широкий выбор вариантов цветового исполнения из всего ассортимента Prodir. Ручка выпускается во всех 4 вариантах отделки: матированная, прозрачная, матовая и полированная.

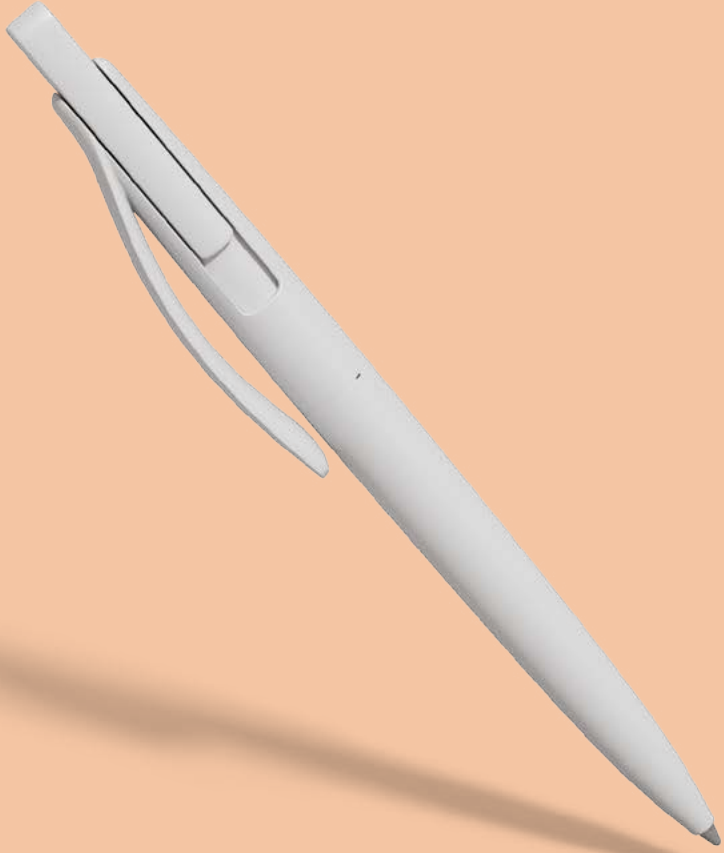

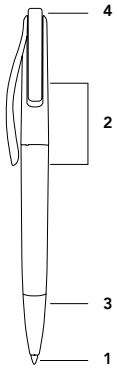
**product code**

**1 writing system**  
**P** Push ball pen

**2 surface**  
**F** Frosted  
**T** Transparent  
**M** Matt  
**P** Polished  
**V** Varnished matt  
**A** Varnished polished

**3 nose cone**  
**F** Frosted  
**T** Transparent  
**M** Matt  
**P** Polished  
**V** Varnished matt  
**A** Varnished polished  
**S** Satin finish metal  
**C** Chrome finish metal

**4 button**  
**F** Frosted  
**T** Transparent  
**M** Matt  
**P** Polished  
**Y** Galvanised satin  
**Z** Galvanised chrome

1	2	3		4
P	F	S	-	F

**print areas****A button, right**

30 × 4 mm  
 1,18" × 0,16"  
 1 colour

**metal button, right**

30 × 4 mm  
 1,18" × 0,16"  
 laser engraving

**B clip**

40 × 8 mm  
 1,57" × 0,31"  
 6 colours

**C button, left**

30 × 4 mm  
 1,18" × 0,16"  
 1 colour

**metal button, left**

30 × 4 mm  
 1,18" × 0,16"  
 laser engraving

**D back cap**

40 × 5 mm  
 1,57" × 0,20"  
 1 colour

**E body**

30 × 28 mm  
 1,18" × 1,10"  
 4 colours

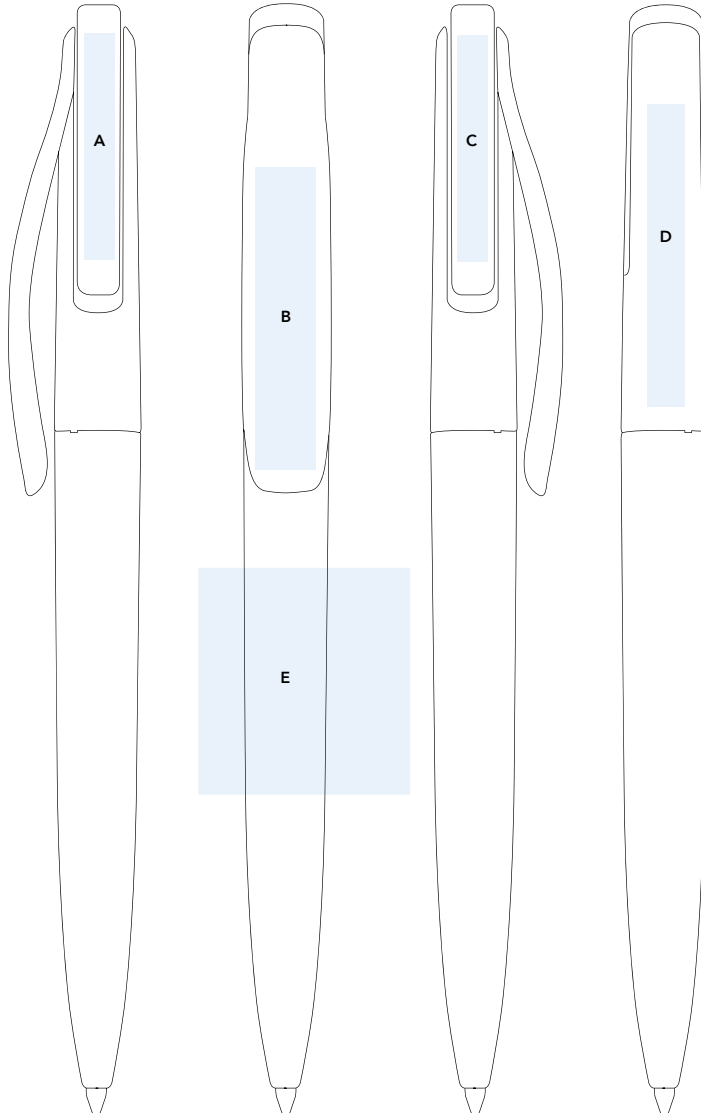

Standard refill:  
 Floating Ball® 1.0 mm.  
 Discover other options  
 on page 172.  
 All Prodir pens are refillable.

surfaces  
and colours

**F - Frosted**

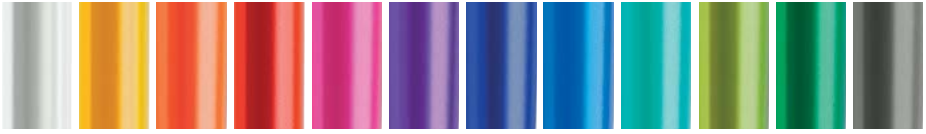

F01 F06 F10 F20 F25 F30 F50 F55 F35 F45 F42 F76

**T - Transparent**

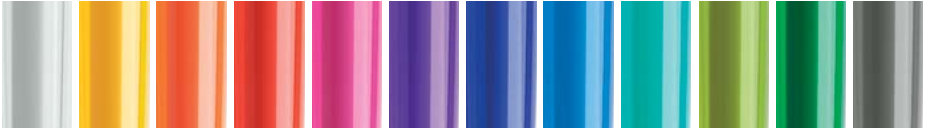

T01 T06 T10 T20 T25 T30 T50 T55 T35 T45 T42 T76

**M - Matt**

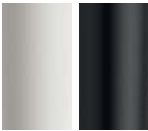

M02 M75

**P - Polished**

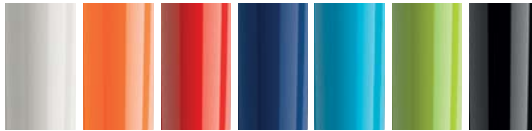

P02 P10 P20 P52 P58 P41 P75

**V - Varnished matt**



V03 V70

**A - Varnished polished**



A70

button surfaces  
and colours

**F - Frosted**



F01 F06 F10 F20 F25 F30 F50 F55 F35 F45 F42 F76

**T - Transparent**



T01 T81 T06 T82 T10 T20 T25 T30 T50 T55 T35 T45 T42 T46

**M - Matt**



M02 M75

**P - Polished**



P02 P10 P20 P52 P58 P41 P75

button option

**Y - Galvanised satin**



Y70

**Z - Galvanised chrome**



Z70

nose cone  
option

**S - Satin finish metal**



**C - Chrome finish metal**



F01

F01

T55

F55

T06

T06

DS2 PFS-F

DS2 PFF-T

DS2 PTC-T



T45

T45

T50

T50

Matt

P10

M75

M02

DS2 PTT-T

DS2 PTC-T

DS2 PMM-P



Polished

Y70

M75

T20

P20

Z70

P58

DS2 PMS-Y



DS2 PPP-T



DS2 PPP-Z



Varnished matt

Varnished polished

T20

Z70

Z70

P02

V03

A70

DS2 PPP-T

DS2 PVV-Z

DS2 PAC-Z





Prodir's absolute bestseller, the DS3 is the pen for strong promotional impact. Its iconic design is synonymous with quality and underlines your brand's credibility. The ring where the cap meets the clip offers an opportunity to highlight the pen's shape. The wide and slightly curved clip, on the other hand, is perfect for colour printing. The Biotic version uses biodegradable materials for the body, cap and mechanism: the entire pen is 80% decomposable.

**DEU** Prodir's absoluter Bestseller. Der DS3 ist ein Kugelschreiber mit einer starken Werbewirkung. Das ikonische Design kann mit Qualität gleichgesetzt werden und unterstreicht die Glaubwürdigkeit Ihrer Marke. Der Ring zwischen Kappe und Clip bietet eine Möglichkeit die Form des Kugelschreibers hervorzuheben. Der breite und leicht geschwungene Clip ist andererseits perfekt geeignet, um farbig bedruckt zu werden. Für die Biotic-Ausführung werden für das Gehäuse, die Kappe und den Mechanismus biologisch abbaubare Materialien verwendet. Der gesamte Kugelschreiber ist zu 80% abbaubar.

**FRA** Best-seller absolu de Prodir, le DS3 est le stylo qui assure un fort impact promotionnel. Son design emblématique est synonyme de qualité et souligne la crédibilité de votre marque. La bague à la jonction du capuchon et de l'agrafe met en valeur la forme du stylo. L'agrafe, large et légèrement courbée, est parfaite pour une impression d'un message publicitaire.

La version Biotic utilise des matériaux biodégradables pour le corps, le capuchon et le mécanisme : le stylo complet est décomposable à 80 %.

**ESP** El DS3, el éxito de ventas absoluto de Prodir, es el bolígrafo perfecto para alcanzar un fuerte impacto promocional. Su icónico diseño es sinónimo de calidad y subraya la credibilidad de su marca. El anillo situado entre el capuchón y el clip constituye una oportunidad única para destacar la silueta del bolígrafo. Por otra parte, el clip ancho y ligeramente curvado es ideal para dar un toque efectista de color del mensaje de comunicación. La versión Biotic emplea materiales biodegradables en la carcasa, el capuchón y el mecanismo: el bolígrafo completo es degradable al 80%.

**ITA** Autentico best seller tra le penne Prodir, la DS3 ha da sempre un forte impatto in ambito promozionale. Il suo design iconico è sinonimo di qualità, e favorisce la credibilità del brand. L'anello di transizione tra il corpo e il cappuccio è

un punto luce che ne accende le forme. La clip, ampia e leggermente ricurva, è invece perfetta per la marcatura a colori. Nella versione Biotic, corpo, cappuccio e meccanismo sono realizzati con materie prime biodegradabili: l'intera penna è compostabile all'80%.

**CYR** Безусловный лидер продаж в ассортименте Prodir. Ручка DS3 способна оказывать мощное рекламное воздействие. Ее стильный дизайн является синонимом качества и подчеркивает авторитетность вашей торговой марки. Кольцо в том месте, где колпачок соединяется с зажимом, позволяет акцентировать форму ручки. Широкий и слегка изогнутый зажим идеально подходит для выполнения цветной печати. При изготовлении данной ручки в исполнении Biotic для производства корпуса, колпачка и механизма применяются биоразлагаемые материалы: вся ручка на 80% может быть подвергнута биоразложению.

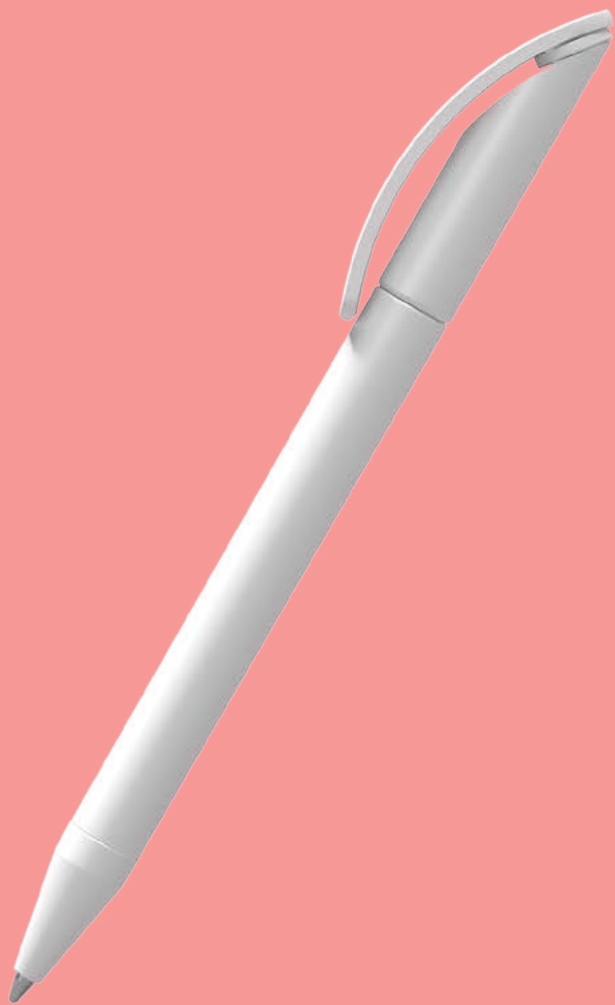

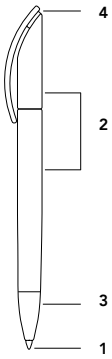
**product code****1 writing system**

T Twist ball pen  
M Mechanical pencil

**2 surface**

F Frosted  
T Transparent  
M Matt  
P Polished  
V Varnished matt  
A Varnished polished  
R Soft Touch  
B Biotic

**3 nose cone**

F Frosted  
T Transparent  
M Matt  
P Polished  
V Varnished matt  
A Varnished polished  
R Soft Touch  
B Biotic  
S Satin finish metal  
C Chrome finish metal

**4 option**

X Ring

**Fastlane**

Find out more on page 241

1	2	3		4
T	F	S	-	X

**print areas****A side cap**

28 × 4 mm  
1,10" × 0,16"  
1 colour  
(not available for  
Biotic surface)

**Soft Touch version**

1 colour\*

**B clip**

40 × 8 mm  
1,57" × 0,31"  
6 colours

**Soft Touch version**

1 colour\*

**C back cap**

25 × 4 mm  
0,98" × 0,16"  
1 colour  
(not available for  
Soft Touch surface)

**D body**

50 × 25 mm  
1,97" × 0,98"  
4 colours  
(not available for  
Soft Touch surface)

\*black, white or silver.

Evaluated upon request:

- Printing up to 2 colours
- PMS

Standard refill:

Floating Ball® 1.0 mm.

Discover other options  
on page 172.

All Prodir pens are refillable.

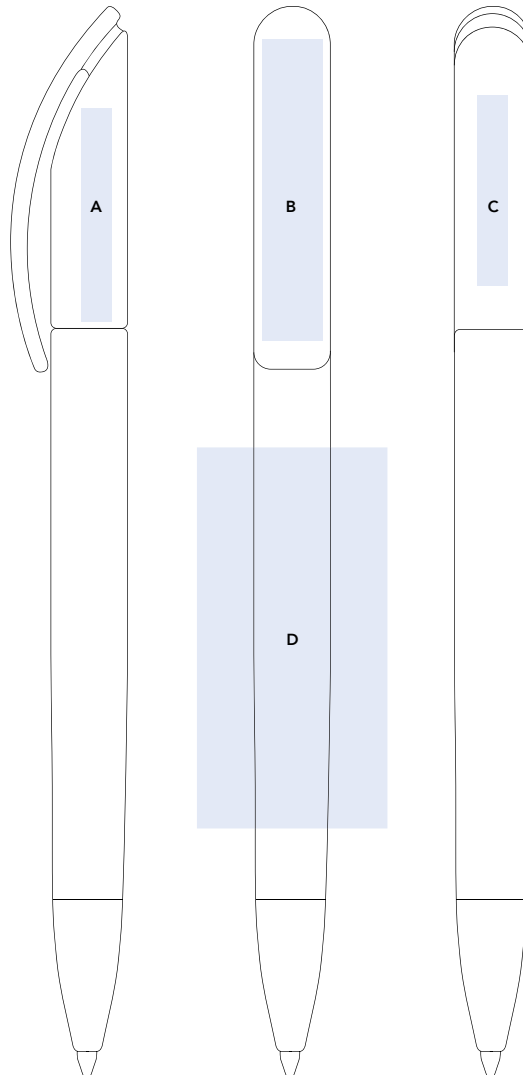

surfaces and colours

**F - Frosted**

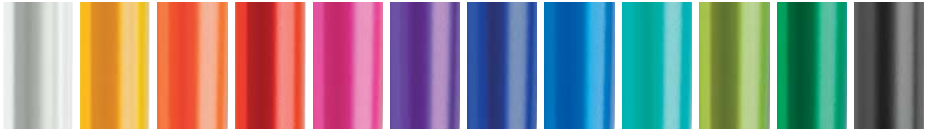

F01• F06• F10• F20 F25 F30 F50 F55• F35 F45 F42 F75•

**T - Transparent**



T01• T06• T10• T20 T25 T30 T50 T55• T35 T45 T42 T75•

**M - Matt**

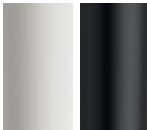

M02 M75

**P - Polished**



P02 P06 P10 P20 P52 P58 P75

**V - Varnished matt**

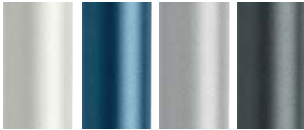

V03 V51 V70 V75

**A - Varnished polished**



A70

**R - Soft Touch**



R10 R21 R50 R75

**B - Biotic (standard PLA, B04 PLA & wood powder)**

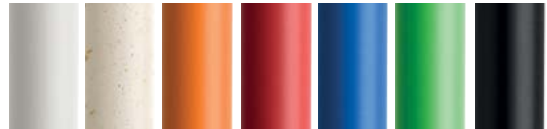

B02 B04 B10 B21 B52 B40 B75

• Also for mechanical pencil

ring option surfaces and colours\*

**X - Polished**



X01 X06 X10 X20 X25 X30 X52 X55 X58 X35 X42 X40 X70 X75

\* Ring option not available for Soft Touch

nose cone option

**S - Satin finish metal**



**C - Chrome finish metal**



F20

DS3 TFF



F06

DS3 TFF



T50

DS3 TTC



Matt

T30

X70

M02

X06

M75

DS3 TTT

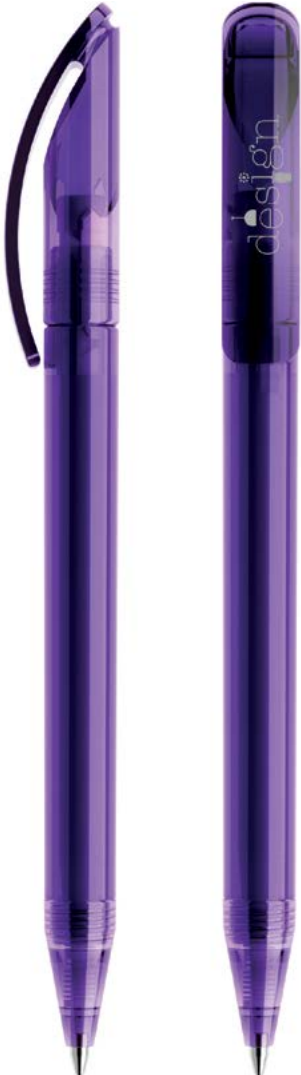

DS3 TMS-X



DS3 TMS-X



Polished

Varnished matt

Varnished polished

X01

P20

V70

A70

DS3 TPP-X

DS3 TVS

DS3 TAA

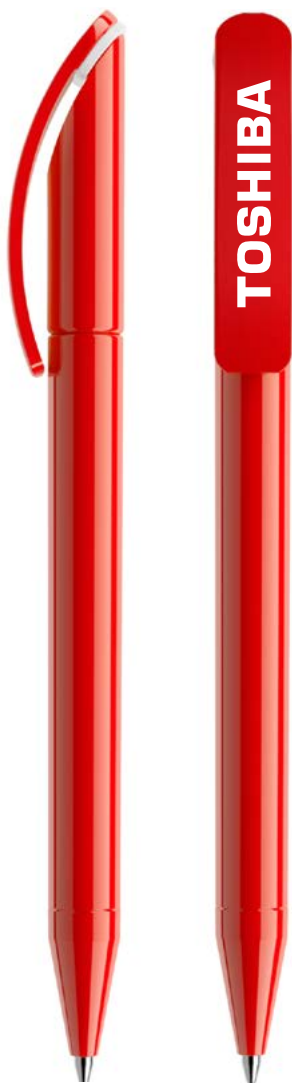

Soft Touch

Biotic



---

DS3 TRR

---

DS3 TBB

---

DS3 TBB

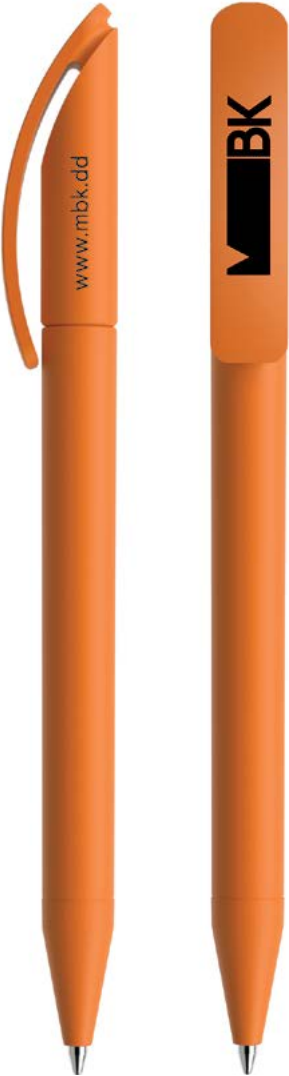



Because design and innovation never stop. The DS3.1 is the evolution of the iconic DS3, with a wider clip, a softer, quieter rotation mechanism and increased visibility in the transparent version. It boasts a range of selected colours only available in this deluxe version.

**DEU** Denn bei Design und Innovation gibt es keine Grenzen. Der DS3.1 ist eine Weiterentwicklung des ikonischen DS3 mit einem breiteren Clip sowie einem weicheren, leiseren Drehmechanismus und er ist in seiner transparenten Ausführung deutlich auffälliger. Er verfügt über eine ausgewählte Farbpalette, die nur für diese Deluxe-Ausführung zur Verfügung steht.

**FRA** Parce que le design et l'innovation ne cessent jamais. Le DS3.1 est une évolution de l'emblématique DS3, avec une agrafe plus large, un mécanisme de rotation plus doux et plus silencieux et une visibilité accrue en version transparente. Il dispose d'une gamme de coloris sélectionnés,

uniquement disponibles dans cette version de luxe.

**ESP** El diseño y la innovación no se detienen nunca. El DS3.1 representa una evolución del icónico DS3, con un clip aun más ancho, un mecanismo de giro más suave y cómodo y más visibilidad en la versión transparente. Disponible en una gama de colores seleccionados, exclusivos de esta versión deluxe.

**ITA** Perché innovazione e design non si fermano mai. La DS3.1 è un'evoluzione dell'iconica DS3, con una clip ancora più ampia e un meccanismo a rotazione più morbido e silenzioso, reso visibile dalla

versione trasparente. Vanta una gamma di colori ricercati che la rendono ancora più preziosa.

**CYR** Дизайн и инновации не имеют границ. Ручка DS3.1 представляет собой вариант дальнейшего развития стильной модели DS3. Она отличается более широким зажимом, более мягким и бесшумным поворотным механизмом и повышенной заметностью благодаря прозрачному корпусу. Доступны варианты выбора цветового исполнения, которые предлагаются только для моделей класса люкс.

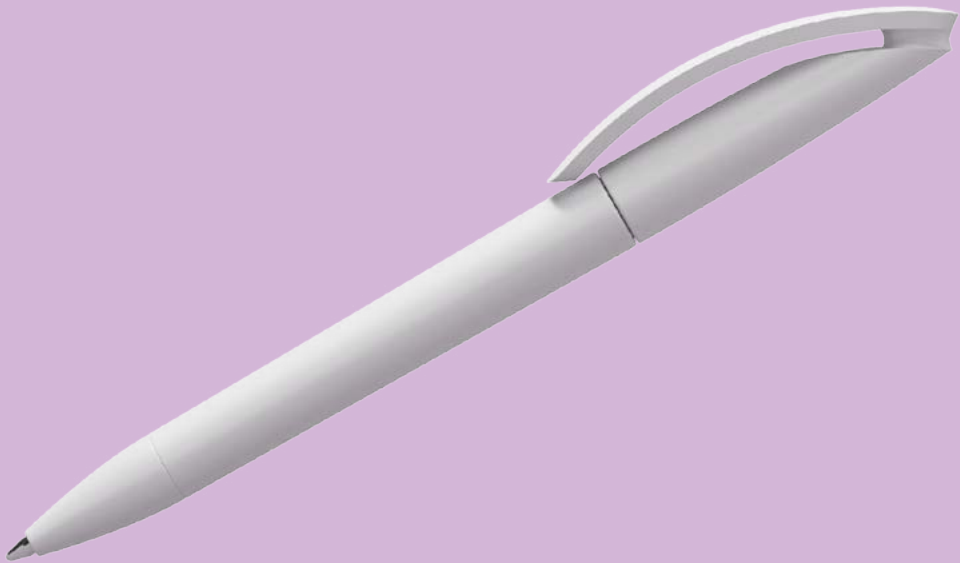

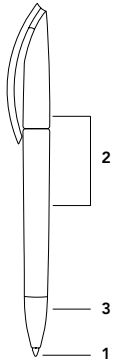

**product code**

**1 writing system**  
**T** Twist ball pen  
 with extra smooth  
 mechanism

**2 surface**  
**F** Frosted  
**T** Transparent  
**P** Polished

**3 nose cone**  
**F** Frosted  
**T** Transparent  
**P** Polished  
**S** Satin finish metal  
**C** Chrome finish metal

1	2	3
T	T	C

**print areas**

- A side cap**  
 25 x 4 mm  
 0,98" x 0,16"  
 1 colour
- B clip**  
 40 x 8 mm  
 1,57" x 0,31"  
 6 colours
- C back cap**  
 28 x 4 mm  
 1,10" x 0,16"  
 1 colour
- D body**  
 40 x 28 mm  
 1,57" x 1,10"  
 4 colours

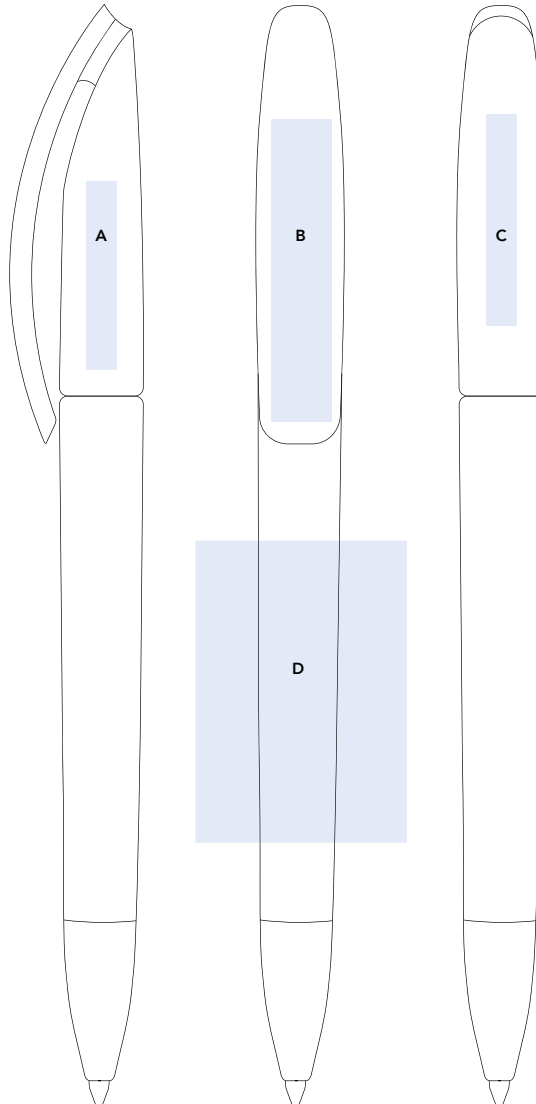

Standard refill:  
 Floating Ball® 1.0 mm.  
 Discover other options  
 on page 172.  
 All Prodir pens are refillable.

surfaces  
and colours

**F - Frosted**

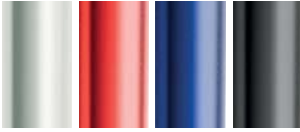

F01 F26 F59 F75

**T - Transparent**

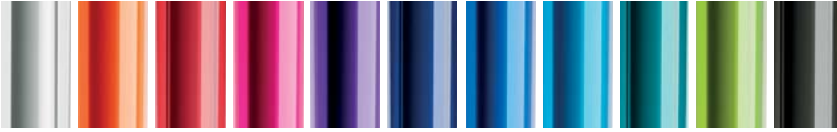

T01 T10 T26 T25 T30 T59 T55 T53 T36 T48 T75

**P - Polished**

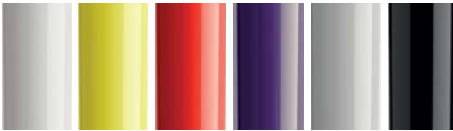

P02 P07 P20 P31 P77 P75

nose cone  
option

**S - Satin finish metal**



**C - Chrome finish metal**





DS3.1 TFS



DS3.1 TFS



DS3.1 TFS



Transparent

T48

DS3.1 TTC



T55

DS3.1 TTT



T26

DS3.1 TTT



T30

DS3.1 TTT



T59

DS3.1 TTC



T25

DS3.1 TTT



Polished

P02

DS3.1 TPP



P20

DS3.1 TPC



P75

DS3.1 TPP

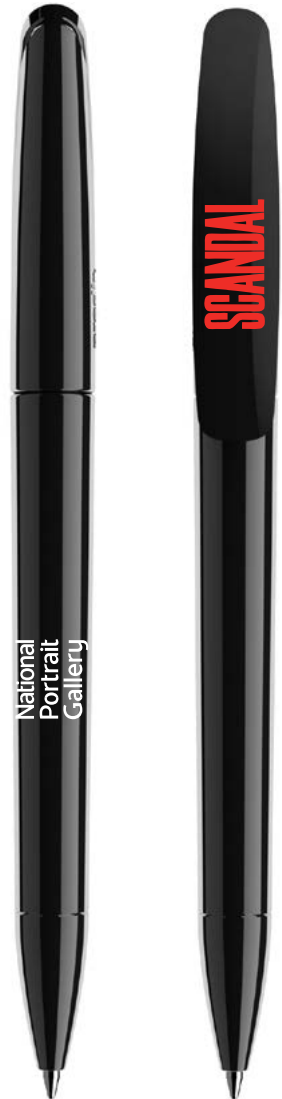



Colours, personalisation options, space and print surfaces: the DS5 is an extremely versatile pen, with a linear design that won the Good Design Award. The defining feature of this pen is the clip, which can be combined with a range of different covers. Choose a coloured cover for contrasting or matching colour combinations or a transparent option with space to insert an image of your choice. And, of course, the pen also comes with multiple printing options.



Good Design  
Award Winner

**DEU** Viele verschiedene Farben, Personalisierungsmöglichkeiten, Oberflächenfinishes und bedruckbare Flächen. Der DS5 ist ein äußerst vielseitiger Kugelschreiber mit einem linearen Design, das die Auszeichnung Good Design Award erhalten hat. Der Clip, der mit einer Auswahl verschiedener Clip-Cover kombiniert werden kann, ist das entscheidende Merkmal dieses Kugelschreibers. Durch die Wahl eines bunten Covers können passende Farben kombiniert oder Kontraste geschaffen werden und falls das transparente Clip-Cover gewählt wird, besteht die Möglichkeit, ein Bild in den Clip einzufügen. Natürlich verfügt der Kugelschreiber noch über viele weitere Flächen, auf denen er bedruckt werden kann.

**FRA** Couleurs, options de personnalisation, espace et surfaces d'impression: le DS5 est un stylo extrêmement polyvalent, avec un design linéaire qui a remporté le Good Design Award. La principale caractéristique de ce stylo est son agrafe qui peut être associée à

toute une gamme de clip covers. Choisissez un clip cover coloré afin de réaliser des combinaisons de couleurs contrastées ou assorties ou bien une option transparente avec un espace pour insérer une image de votre choix. Et, bien sûr, le stylo est disponible avec de multiples options d'impression.

**ESP** Colores, opciones de personalización, espacio y superficies de impresión: el DS5 es un bolígrafo muy versátil con un diseño lineal que ganó el Good Design Award. El elemento más característico de este bolígrafo es el clip, que se puede combinar con una gama de tapas distintas. Seleccione una tapa de color para lograr efectos de contraste o de armonía u opte por una versión transparente, con espacio para insertar la imagen de papel impreso que desee. Y, por supuesto, el bolígrafo ofrece distintas opciones de impresión.

**ITA** Colori, personalizzazioni, superfici, aree di stampa: la DS5 è una penna estremamente versatile, con un design lineare che ha vinto il Good Design Award.

Il tratto distintivo è rappresentato dalla clip. Su di essa è possibile applicare una cover colorata, creando effetti cromatici a contrasto o tono su tono; o un inserto grafico impreziosito da una sovraclip trasparente. Il tutto accompagnato a molteplici possibilità di stampa.

**CYR** Больше цветов, больше вариантов для индивидуализации, больше места, больше пространства для печати: DS5 – это абсолютно универсальная ручка, линейный дизайн которой завоевал широкое признание. Ее отличительной характеристикой является зажим, для которого предлагается большое количество вариантов цветового исполнения. Можно выбрать вставную пластину, цвет которой контрастирует с цветом ручки или соответствует ему, а также прозрачную пластину, в свободное пространство под которой вставляется любое изображение по выбору. И, конечно же, предлагаются альтернативные варианты для нанесения на ручку печатных изображений.

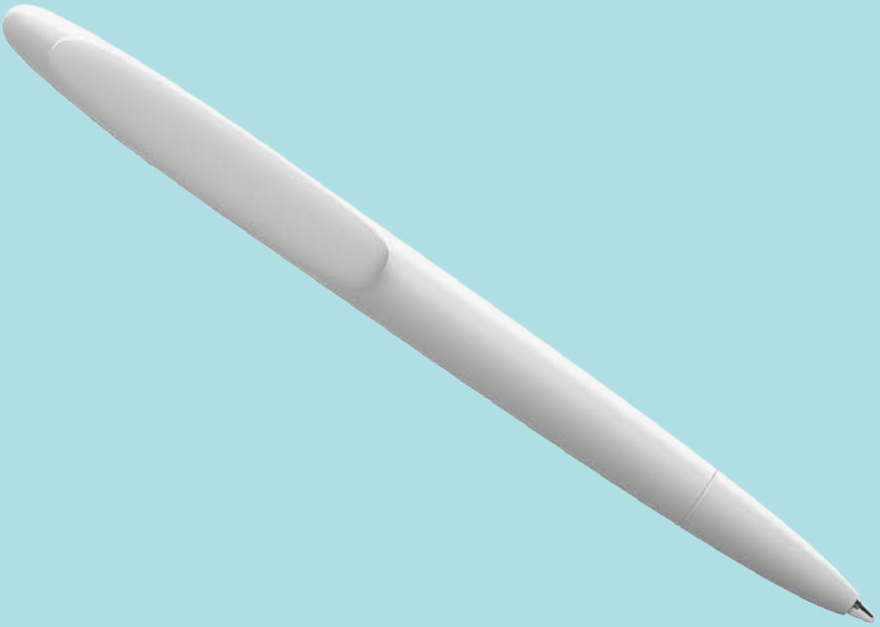

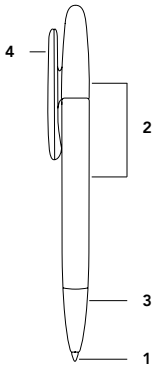
**product code**

**1 writing system**  
T Twist ball pen

**2 surface**  
F Frosted  
T Transparent  
M Matt  
P Polished  
V Varnished matt  
A Varnished polished  
R Soft Touch

**3 nose cone**  
F Frosted  
T Transparent  
M Matt  
P Polished  
V Varnished matt  
A Varnished polished  
R Soft Touch  
S Satin finish metal  
C Chrome finish metal

**4 option clip cover**  
T Transparent  
M Matt  
P Polished

**Fastlane**

Find out more on page 241

1	2	3		4
T	F	S	-	P

**print areas**

**A side cap**  
23 × 5 mm  
0,90" × 0,20"  
1 colour

**B clip**  
40 × 7 mm  
1,57" × 0,28"  
6 colours

**C back cap**  
23 × 5 mm  
0,90" × 0,20"  
1 colour

**D body**  
35 × 30 mm  
1,38" × 1,18"  
4 colours

**E clip base**  
35 × 6 mm  
1,38" × 0,24"  
6 colours

**F clip cover**  
40 × 7 mm  
1,57" × 0,28"  
2 colours

Soft Touch surfaces  
are not printable.

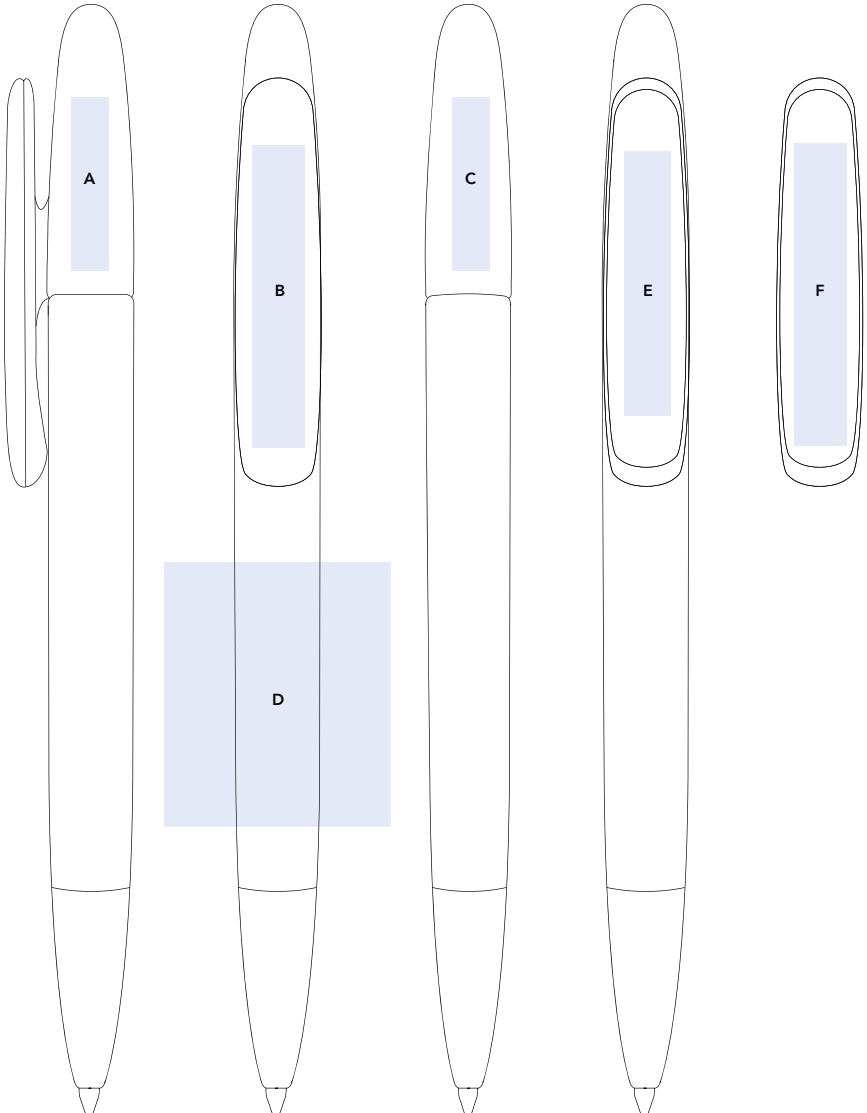

Standard refill:  
Floating Ball® 1.0 mm.  
Discover other options  
on page 172.  
All Prodir pens are refillable.

surfaces and colours

**F - Frosted**

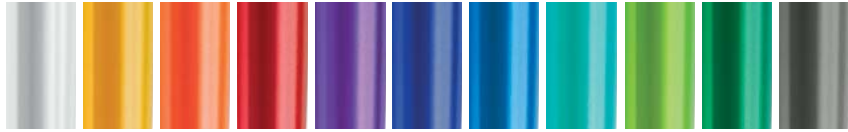

F01 F06 F10 F21 F30 F50 F51 F35 F41 F42 F76

**T - Transparent**

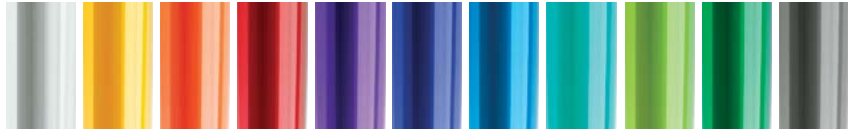

T01 T06 T10 T21 T30 T50 T51 T35 T41 T42 T76

**M - Matt**



M02 M75

**P - Polished**



P02 P06 P10 P20 P52 P58 P75

**V - Varnished matt**



V03 V51 V70 V75

**A - Varnished polished**



A70

**R - Soft Touch**



R75

clip cover option\*

**T - Transparent**

**P - Polished**

**M - Matt**

surfaces and colours



T01 P02 P10 P20 P52 P58 P75 M02 M75

\* Clip cover option not available for varnished surface

inlay option

**Image inlay (4 colours process printing, CMYK)**



nose cone option

**S - Satin finish metal**

**C - Chrome finish metal**





---

DS5 TFF

---

DS5 TFF

---

DS5 TTC



Matt

T01

T42

T50

M02

DS5 TTC-T



DS5 TTT



DS5 TMS



Polished

P02

P20

P75

P52

DS5 TPP-P

DS5 TPC

DS5 TPC



Varnished matt

Varnished polished

Soft Touch

V75

A70

P02

R75

DS5 TVS

DS5 TAA

DS5 TRR-P





Designed with extreme care, the DS6 is a pen with an informal design that adapts perfectly to the hand, thanks to an ergonomic rounded body. The slightly concave clip integrates perfectly with the button. A selection of contemporary tones enriches the classic colour range, increasing versatility and the options for personalisation. The defining feature of the DS6 is its surface, which is partly finished in matt and partly in polished. The result is extreme contrast on a single surface, making the DS6 a real one-of-a-kind.

**DEU** Der mit besonderer Sorgfalt entworfene DS6 ist ein Kugelschreiber mit einem schlichten Design, das sich dank des ergonomisch abgerundeten Schaftes perfekt der Fingerhaltung anpasst. Der leicht konkave Clip ist perfekt auf den Knopf abgestimmt. Moderne Farben bereichern seine Farbpalette und bieten weitere Personalisierungsmöglichkeiten. Dieser Kugelschreiber vereint zwei Oberflächen auf seinem Schaft, matt und poliert, die einen starken Kontrast erzeugen und somit den DS6 zu einem einzigartigen Produkt machen.

**FRA** Conçu avec un soin extrême, le DS6 est un stylo au design informel qui s'adapte parfaitement à la main, grâce à un corps ergonomique arrondi. L'agrafe légèrement concave s'associe parfaitement au poussoir. Une sélection de tons contemporains enrichit la gamme des couleurs classiques, augmentant la polyvalence et les possibilités de personnalisation. La caractéristique principale du DS6 est sa surface, avec une finition en partie mate et

en partie polie. Le résultat est un contraste extrême sur une seule surface, ce qui fait du DS6 une pièce véritablement unique.

**ESP** Diseñado con gran atención a los detalles, el DS6 destaca por su diseño informal que, gracias a su cuerpo redondeado y ergonómico, se adapta a la perfección a la mano. El clip, ligeramente cóncavo, forma un conjunto armonioso con el botón. Una selección de colores modernos complementa la gama clásica de colores, aumentando la versatilidad y las opciones de personalización. El rasgo más característico del DS6 es su superficie, con una parte de acabado mate y otra en pulido. El resultado: un contraste llamativo en una sola superficie, que hace del DS6 un bolígrafo único.

**ITA** Disegnata con estrema cura, la DS6 è una penna dal design informale che si adatta perfettamente all'impugnatura, grazie a un corpo bombato ed ergonomico. La clip, leggermente concava, si integra perfettamente con il pulsante. Una

selezione di tonalità contemporanee arricchisce la gamma di colori classica, aumentando la versatilità e le possibilità di personalizzazione. Il tratto distintivo della DS6 è la superficie: sul corpo convivono una parte opaca e una parte lucida. Il risultato è un forte contrasto tra superfici che rende la DS6 un prodotto inimitabile.

**CYR** Неформальный дизайн ручки DS6 создавался с особой тщательностью. Ее эргономичный закругленный корпус идеально помещается в руке. Слегка изогнутый зажим гармонично соединяется с кнопкой. Палитра современных тонов дополняет классический выбор цветов. Все это повышает универсальность и расширяет возможности для индивидуализации. Отличительной характеристикой ручки DS6 является ее поверхность, которая частично матирована, а частично отполирована. Результатом такого сочетания является яркий контраст, делающий ручку DS6 по-настоящему единственной и неповторимой.

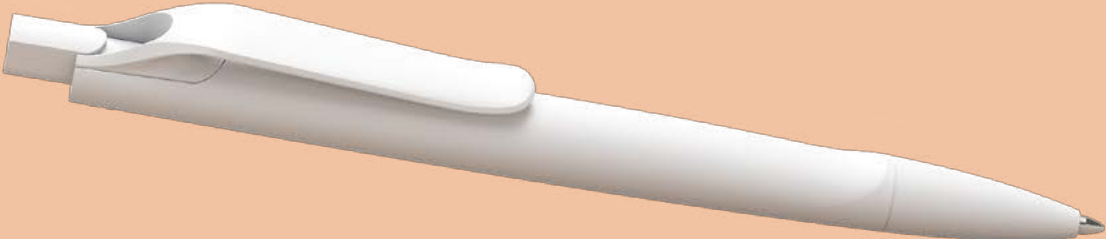

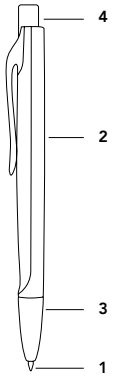

**product code**

**1 writing system**  
**P** Push ball pen

**2 surface**  
**P** Polished  
**R** Soft Touch

**3 nose cone**  
**P** Polished  
**R** Soft Touch  
**C** Chrome finish metal

**4 button**  
**P** Polished  
**Y** Galvanised satin  
**Z** Galvanised chrome

1	2	3		4
P	P	P	-	Y

**print areas**

**A clip**  
 38 x 7 mm  
 1,49" x 0,27"  
 6 colours

**B back**  
 40 x 5 mm  
 1,57" x 0,20"  
 6 colours

**Soft Touch version**  
 1 colour\*

- \*black, white or silver.  
 Evaluated upon request:
- Printing up to 2 colours
  - PMS

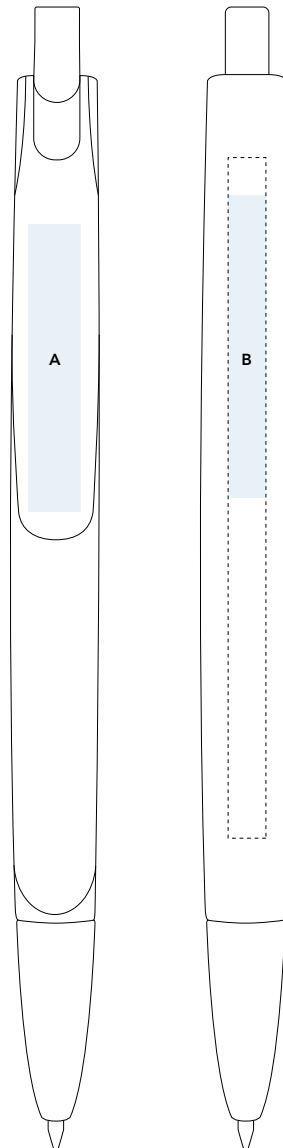

Standard refill:  
 Floating Ball® 1.0 mm.  
 Discover other options  
 on page 172.  
 All Prodir pens are refillable.

surfaces  
and colours

**P - Polished**

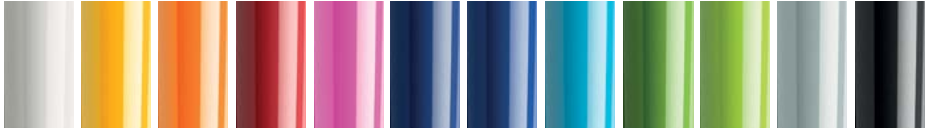

P02\*\* P06\* P10\* P21\* P23\* P63\*\* P52\* P58\* P68\*\* P48\* P79\* P75\*\*

**R - Soft Touch**



R10\* R21\* R23\* R63\*\* R50\* R58\* R68\*\* R48\* R79\* R75\*\*

\* Standard with transparent clip & button  
\*\* Standard with polished clip & button

clip

**T - Transparent**



T06 T10 T21 T25 T50 T53 T48 T79

**P - Polished**



P02 P63 P68 P75

button

surfaces  
and colours

**P - Polished**



P02 P06 P10 P21 P23 P63 P52 P58 P68 P48 P79 P75

button option

**Y - Galvanised satin**



Y70

**Z - Galvanised chrome**



Z70

nose cone  
option

**C - Chrome finish metal**





DS6 PPC-P

DS6 PPP-P

DS6 PPP-P



Y70

T53

P58

P79

T79

P79

P10

T10

P10

DS6 PPC-Y



DS6 PPP-P



DS6 PPP-P



Soft Touch

P21

T21

R21

P23

T25

R23

Z70

T48

R48

DS6 PRR-P



DS6 PRR-P



DS6 PRC-Z



Y70

T50

R50

Z70

P75

R75

P79

T79

R79

DS6 PRR-Y



DS6 PRC-Z



DS6 PRC-P





The pen surface, which already fully embraces its own identity, is ignited with colour thanks to the numerous finishes available for the central button. The DS7 is a simple and refined pen with soft lines and well-balanced components. Its different print areas, wide colour range and elegant chrome or polished nose cone mean that it adapts perfectly to the message it carries, for precise and accurate communication.



The Promotional  
Gift Award Winner

**DEU** Der elegante Druckknopf in der Gehäusemitte setzt Akzente auf einer Oberfläche, die dank der vielen erhältlichen Finishes bereits eine ganz eigene Identität verströmt. Der DS7 ist ein schlichter und edler Kugelschreiber mit klaren Linien und gut aufeinander abgestimmten Bauteilen. Aufgrund seiner verschiedenen bedruckbaren Bereiche, der breiten Farbpalette sowie der eleganten, verchromten oder polierten Spitze lässt er sich perfekt anpassen, um die Markenbotschaft präzise zu vermitteln.

**FRA** La surface du stylo, qui exprime pleinement sa propre identité, est éclairée par ses couleurs grâce aux nombreuses finitions disponibles pour le poussoir central. Le DS7 est un stylo importante et raffiné avec des lignes douces et des composants bien équilibrés. Ses différentes zones d'impression, sa large gamme de couleurs et son élégant embout chromé ou poli lui permettent de s'adapter

parfaitement au message qu'il véhicule, pour une communication précise et ciblée.

**ESP** La superficie del bolígrafo, que por sí sola revela su propia identidad, se transforma en un auténtico juego de colores gracias a los numerosos acabados disponibles para el botón central. El DS7 es un bolígrafo importante y elegante de líneas suaves y componentes armonizados entre sí. Gracias a sus distintas áreas de impresión, su amplia gama de colores y su elegante punta metálica en acabado pulido o cromo, se adapta a la perfección al mensaje que transmite y lo comunica con claridad y precisión.

**ITA** Il pulsante al centro accende di colore una superficie già dotata di una propria identità, grazie alle numerose finiture disponibili. La DS7 è una penna elegante e raffinata, dai lineamenti morbidi, le cui componenti sono tra loro in armonico equilibrio. Con le sue differenti

aree di stampa, una ricca gamma di colori e l'elegante puntale cromato o lucido, si adatta perfettamente al messaggio che veicola, comunicandolo in modo accurato e preciso.

**CYR** Необыкновенная поверхность ручки, которая и так в полной мере воплощает в себе индивидуальность, подчеркивается яркими красками за счет большого разнообразия вариантов отделки центральной кнопки. Ручка DS7 отличается простотой и утонченностью, мягкими линиями и гармоничной сбалансированностью элементов. Различные поверхности для выполнения печати, широкий выбор цветов и элегантный конический наконечник из хромированного или полированного материала подчеркивает идеальное соответствие сообщению, которое несет в себе ручка: точность и достоверность.



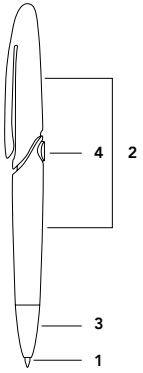

**product code**

**1 writing system**  
**P** Push ball pen

**2 surface**  
**F** Frosted  
**T** Transparent

**M** Matt  
**P** Polished  
**V** Varnished matt  
**A** Varnished polished

**3 nose cone**  
**F** Frosted  
**T** Transparent  
**M** Matt  
**P** Polished  
**V** Varnished matt  
**A** Varnished polished  
**S** Satin finish metal  
**C** Chrome finish metal

**4 button**  
**F** Frosted  
**M** Matt

1	2	3		4
P	F	S	-	F

**print areas**

**A side cap**  
 30 × 5 mm  
 1,18" × 0,20"  
 1 colour

**B clip**  
 45 × 8 mm  
 1,77" × 0,31"  
 6 colours

**C back cap**  
 30 × 7 mm  
 1,18" × 0,28"  
 1 colour

**D body**  
 30 × 33 mm  
 1,18" × 1,30"  
 4 colours

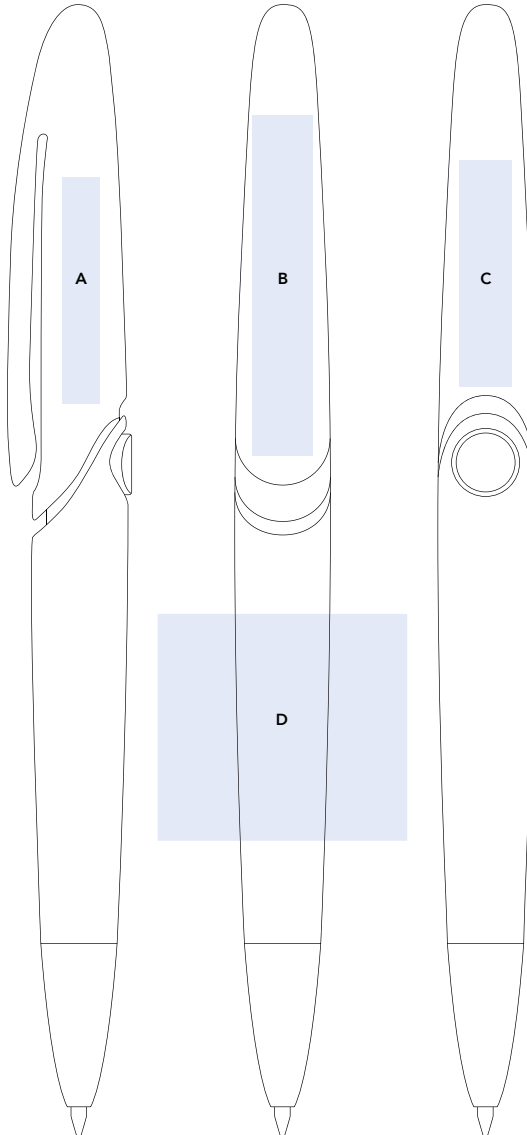

Standard refill:  
 Floating Ball® 1.0 mm.  
 Discover other options  
 on page 172.  
 All Prodir pens are refillable.

surfaces  
and colours

**F - Frosted**

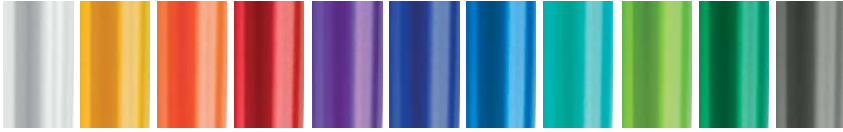

F01 F06 F10 F21 F30 F50 F51 F35 F41 F42 F76

**T - Transparent**

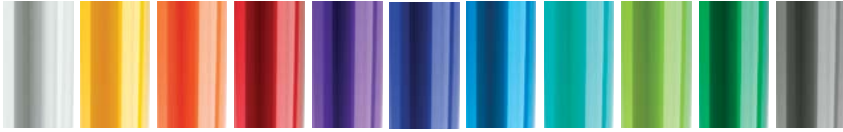

T01 T06 T10 T21 T30 T50 T51 T35 T41 T42 T76

**M - Matt**

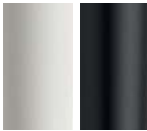

M02 M75

**P - Polished**



P02 P10 P20 P53 P41 P74 P75

**V - Varnished matt**



V03 V70

**A - Varnished polished**



A70

button

surfaces  
and colours

**F - Frosted**



F01 F06 F10 F21 F30 F50 F51 F35 F41 F42 F76

**M - Matt**



M02 M10 M21 M41 M53 M74 M75

nose cone  
option

**S - Satin finish metal**



**C - Chrome finish metal**





DS7 PFS-F



DS7 PFS-F



DS7 PFS-F



Transparent

M02

F21

F50

T10

F06

T50

DS7 PFS-M



DS7 PTT-F



DS7 PTT-F



Matt

Polished

F01

T42

F35

M75

M02

P02

DS7 PTC-F

DS7 PMS-F

DS7 PPC-M



Varnished matt

Varnished polished



DS7 PPP-M

DS7 PVV-F

DS7 PAA-F





An iconic and minimal design that emphasises the triangular body for memorable impact. Ergonomic and functional, the DS8 is available both as a push ball pen and a mechanical pencil. Matt, polished or Soft Touch, it boasts a wide colour range with options for a plastic or metal button. A contemporary classic and fundamental part of the Prodir range. Now finally available in the deluxe version with metal nose cone.

**DEU** Ein ikonisches und minimalistisches Design, das durch seine dreieckige Form begeistert. Der ergonomische und funktionelle DS8 ist als Kugelschreiber und als Druckbleistift erhältlich. Matt, poliert oder mit Soft Touch – verschiedene Farbkombinationen mit Metall- oder Kunststoffknopf stehen zur Verfügung. Ein moderner Klassiker und ein unverzichtbares Produkt im Sortiment von Prodir. Jetzt auch als Deluxe-Ausführung mit Metallspitze erhältlich.

**FRA** Un design emblématique et minimaliste qui met en valeur le corps triangulaire pour un impact marquant. Ergonomique et fonctionnel, le DS8 est disponible à la fois en stylo bille et en porte-mines. Mat, poli ou Soft Touch, il offre combinaisons de couleurs différentes avec un poussoir en plastique ou en métal. Un classique contemporain, un précieux produit de la gamme Prodir. Maintenant enfin disponible dans la version de luxe avec embout métallique.

**ESP** Un diseño icónico y minimalista que resalta su cuerpo triangular logrando un efecto impactante. Ergonómico y funcional, el DS8 está disponible como bolígrafo a presión y como portaminas. En mate, pulido o Soft Touch, ofrece combinaciones distintas de color con un botón metálico o de plástico. Un clásico contemporáneo y un producto imprescindible de la gama Prodir. Y, por fin, ya está disponible en la versión deluxe con punta de metal.

**ITA** Un design iconico e minimale che esalta la forma triangolare del corpo, rendendolo memorabile. Ergonomica e funzionale, la DS8 è disponibile sia come penna a sfera sia come portamine a pressione. Opaca, lucida e Soft Touch, vanta una gamma colori ampia, combinabile con pulsante in plastica o metallo. Un classico contemporaneo, irrinunciabile nella gamma Prodir. Ora finalmente disponibile in versione più preziosa con puntale in metallo.

**CYR** Стильный минималистичный дизайн подчеркивает треугольный корпус, который создает запоминающееся впечатление. Отличающаяся эргономичностью и функциональностью модель DS8 предлагается в виде автоматической шариковой ручки или механической ручки. Предлагается исполнение с матовой, полированной или мягкой поверхностью Soft Touch при широком разнообразии цветовых вариантов. При изготовлении этой ручки может использоваться пластмассовая или металлическая кнопка. DS8 – значимый элемент ассортимента продукции Prodir, воплощающий в себе современную классику. Теперь предлагается и вариант дельюкс с металлическим конусным наконечником.

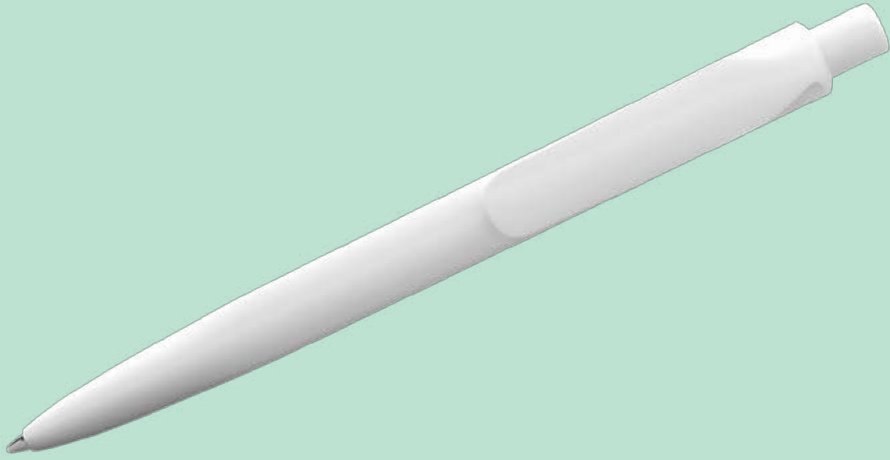

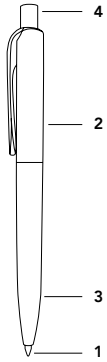

**product code**

- 1 writing systems**
- P** Push ball pen
- M** Mechanical Pencil

mechanical pencil only  
with satin or chrome  
finish metal button

- 2 cap**
- M** Matt
- P** Polished
- R** Soft Touch

- 3 body**
- M** Matt
- P** Polished
- R** Soft Touch

- 4 button option**
- S** Satin finish metal
- C** Chrome finish metal

1	2	3		4
P	M	M	-	S

**print areas**

- A side cap**
- 38 × 5 mm
- 1,50" × 0,20"
- 2 colours

- Soft Touch version**
- 1 colour\*

- B clip**
- 36 × 7 mm
- 1,41" × 0,28"
- 6 colours

- C body**
- 36 × 5 mm
- 1,41" × 0,20"
- 2 colours

- Soft Touch version**
- 1 colour\*

- C1 side body**
- 36 × 5 mm
- 1,41" × 0,20"
- 2 colours

- Soft Touch version**
- 1 colour\*

- C2 side body**
- 36 × 5 mm
- 1,41" × 0,20"
- 2 colours

- Soft Touch version**
- 1 colour\*

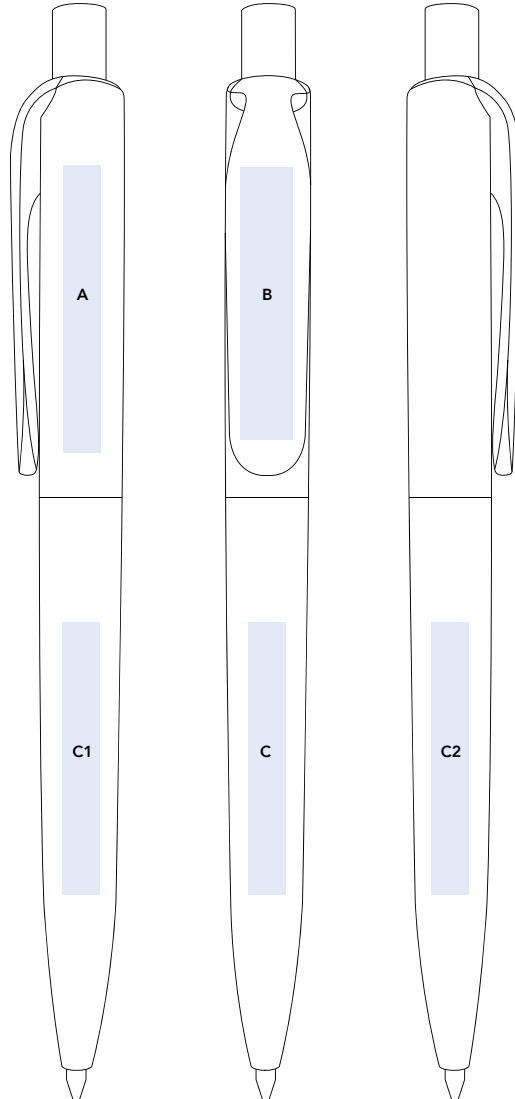

\*black, white or silver.  
Evaluated upon request:  
• Printing up to 2 colours  
• PMS

Standard refill:  
Floating Ball® 1.0 mm.  
Discover other options  
on page 172.  
All Prodir pens are refillable.

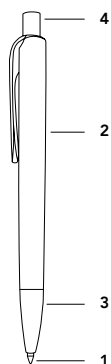
**product code****1 writing systems**

P Push ball pen

**2 surface**

M Matt

P Polished

R Soft Touch

**3 nose cone**

S Satin finish metal

C Chrome finish

metal

**4 button option**

S Satin finish metal

C Chrome finish

metal

1	2	3		4
P	M	S	-	S

**print areas****A side cap**

38 × 5 mm  
1,50" × 0,20"  
2 colours

**Soft Touch version**

1 colour\*

**B clip**

36 × 7 mm  
1,41" × 0,28"  
6 colours

**C body**

36 × 5 mm  
1,41" × 0,20"  
2 colours

**Soft Touch version**

1 colour\*

**C1 side body**

36 × 5 mm  
1,41" × 0,20"  
2 colours

**Soft Touch version**

1 colour\*

**C2 side body**

36 × 5 mm  
1,41" × 0,20"  
2 colours

**Soft Touch version**

1 colour\*

\*black, white or silver.

Evaluated upon request:

- Printing up to 2 colours
- PMS

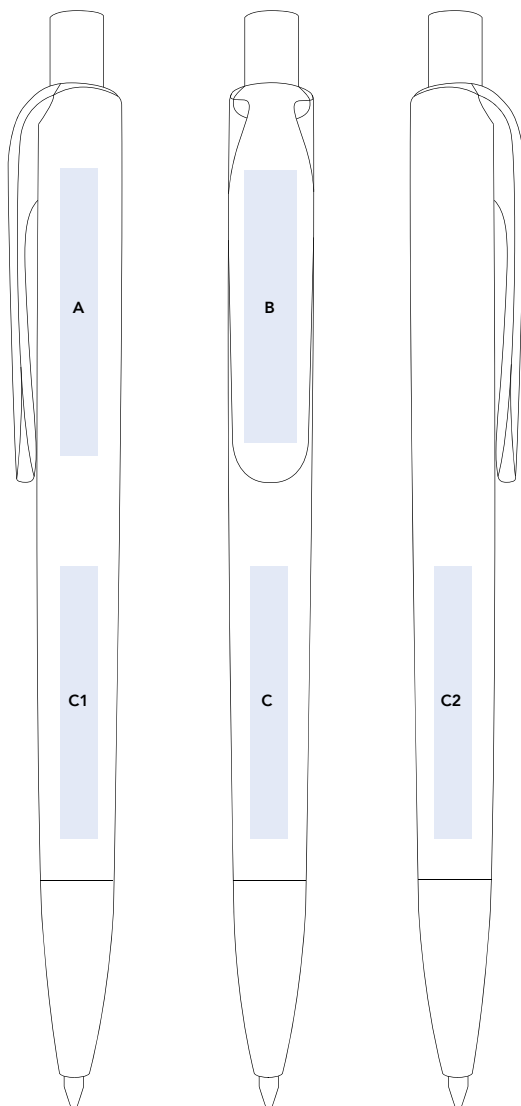

Standard refill:  
Floating Ball® 1.0 mm.  
Discover other options  
on page 172.  
All Prodir pens are refillable.



DS8 PMM

DS8 PMM

DS8 PPC-S



Soft Touch

P02

S70

T28

R28

S70

T76

R70

DS8 PPP



DS8 PRR-S



DS8 PRR-S



S70

T48

R48

S70

T50

R50

C14

P75

R75

C14

DS8 PRR-S



DS8 PRR-S



DS8 PRC-C



surfaces and colours

**M - Matt**



M02\* M07\* M27\* M58\* M47\* M70\*

**P - Polished**



P02\*\* P10\* P20\* P55\* P75\*

**R - Soft Touch**



R10\* R21\* R28\* R50\* R62\* R54\* R48\* R70\* R75\*

clip and button surfaces and colours

**T - Transparent**



T01 T07 T10 T21 T28 T27 T50 T62 T54 T53 T47 T48

**T - Transparent**



T76 T75

**P - Polished**



P02 P75

- Standard with transparent clip & button
- Standard with polished clip & button
- Also for mechanical pencil (only with satin or chrome finish metal button)

button option

**S - Satin finish metal**



S70 S02 S14 S75 S80

**C - Chrome finish metal**



C70 C02 C14 C75 C80

nose cone

(not available for mechanical pencil)

**S - Satin finish metal**



S70 S14 S75 S80

**C - Chrome finish metal**

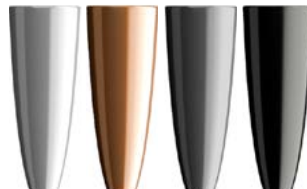

C70 C14 C75 C80



Elegant combinations of plastic and metal for a versatile pen that naturally adapts to the communication strategies of different brands. Clip and button are available in 10 different finishes. Details such as a clip-holder, to match or contrast the pen as desired, make the DS8 Metal Clip a special pen, now available in a deluxe version with metal nose cone.

**DEU** Kunststoff und Metall elegant kombiniert in einem vielseitigen Kugelschreiber, der sich spielerisch einfach an die Kommunikationsstrategien verschiedener Marken anpassen lässt. Der Clip und der Knopf sind in 10 verschiedenen Oberflächenfinishs erhältlich. Details wie ein Clip-Holder, der sich auf Wunsch farblich absetzen lässt, machen den DS8 Metal Clip zu einem besonderen Kugelschreiber, der jetzt auch als Deluxe-Version mit Metallspitze erhältlich ist.

**FRA** Élégantes combinaisons de plastique et de métal pour un stylo polyvalent qui s'adapte naturellement aux stratégies de communication des différents marques. Agrafe et poussoir sont disponibles en 10 finitions différentes. Des détails tels qu'un porte-agrafe pour assortir ou contraster le stylo à votre convenance font du DS8 à agrafe métal un

stylo spécial, maintenant disponible dans une version de luxe avec un embout métal.

**ESP** Elegantes combinaciones de plástico y metal conforman un bolígrafo versátil que se adapta a las estrategias de comunicación de distintas marcas. El clip y el botón están disponibles en 10 acabados distintos. Detalles como el soporte del clip, que puede agregar una nota de contraste o de armonía según sus preferencias, hacen del DS8 Metal Clip un bolígrafo especial. Y ahora está disponible en versión deluxe con punta de metal.

**ITA** Raffinate combinazioni di plastica e metallo per una penna sempre più versatile che si adatta con naturalezza al contesto di comunicazione di brand differenti. È possibile abbinare clip e pulsante in 10 diverse galvaniche. Dettagli come il portacclip, in tinta con il colore del corpo o

da utilizzare come elemento di contrasto, rendono la DS8 Metal Clip una penna speciale, ora disponibile in versione più preziosa con puntale in metallo.

**CYR** Элегантное сочетание пластмассы и металла в универсальной ручке, которая естественным образом адаптируется к коммуникативным стратегиям различных торговых марок. Для зажима и металлической кнопки предлагаются 10 различных вариантов отделки. Такие детали, как зажим-держатель, который соответствует ручке по цвету или контрастирует с ней, делают модель DS8 с металлическим зажимом совершенно особенной. Теперь она предлагается и в исполнении делюкс с металлическим конусным наконечником.

DS8 Metal Clip



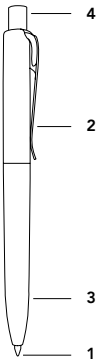

**product code**

**1 writing systems**

- P Push ball pen
- M Mechanical Pencil

**2 clip**

- S Satin finish metal

**3 surface**

- M Matt
- P Polished
- R Soft Touch

**4 button**

- S Satin finish metal
- C Chrome finish metal

1	2	3		4
P	S	M	-	S

**print areas**

**A side cap**

38 × 5 mm  
1,50" × 0,20"  
2 colours

**Soft Touch version**

1 colour\*

**B metal clip**

33 × 6 mm  
1,29" × 0,23"  
3 colours or  
laser engraving

**C body**

36 × 5 mm  
1,41" × 0,20"  
2 colours

**Soft Touch version**

1 colour\*

**C1 side body**

36 × 5 mm  
1,41" × 0,20"  
2 colours

**Soft Touch version**

1 colour\*

**C2 side body**

36 × 5 mm  
1,41" × 0,20"  
2 colours

**Soft Touch version**

1 colour\*

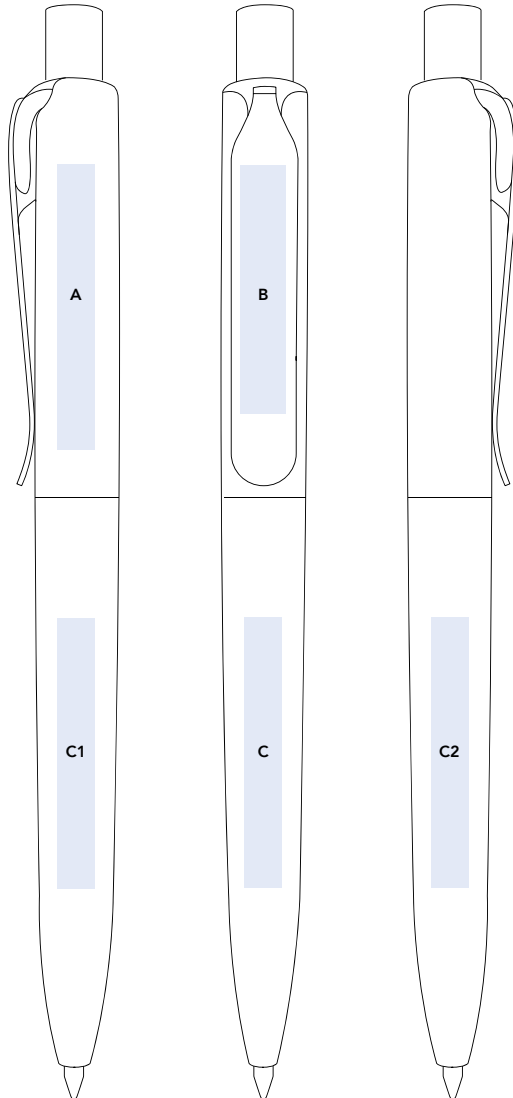

\*black, white or silver.

Evaluated upon request:

- Printing up to 2 colours
- PMS

Standard refill:  
Floating Ball® 1.0 mm.  
Discover other options  
on page 172.  
All Prodir pens are refillable.

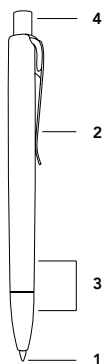
**product code****1 writing systems**

P Push ball pen

**2 clip**

S Satin finish metal

**3 body + nose cone**

H Matt +

Satin finish metal

I Matt+

Chrome finish metal

K Polished +

Satin finish metal

N Polished +

Chrome finish metal

Q Soft Touch +

Satin finish metal

W Soft Touch +

Chrome finish metal

**4 button**

S Satin finish metal

C Chrome finish metal

1	2	3		4
P	S	H	-	S

**print areas****A side cap**

38 × 5 mm  
1,50" × 0,20"  
2 colours

**Soft Touch version**

1 colour\*

**B metal clip**

33 × 6 mm  
1,29" × 0,23"  
3 colours or  
laser engraving

**C body**

36 × 5 mm  
1,41" × 0,20"  
2 colours

**Soft Touch version**

1 colour\*

**C1 side body**

36 × 5 mm  
1,41" × 0,20"  
2 colours

**Soft Touch version**

1 colour\*

**C2 side body**

36 × 5 mm  
1,41" × 0,20"  
2 colours

**Soft Touch version**

1 colour\*

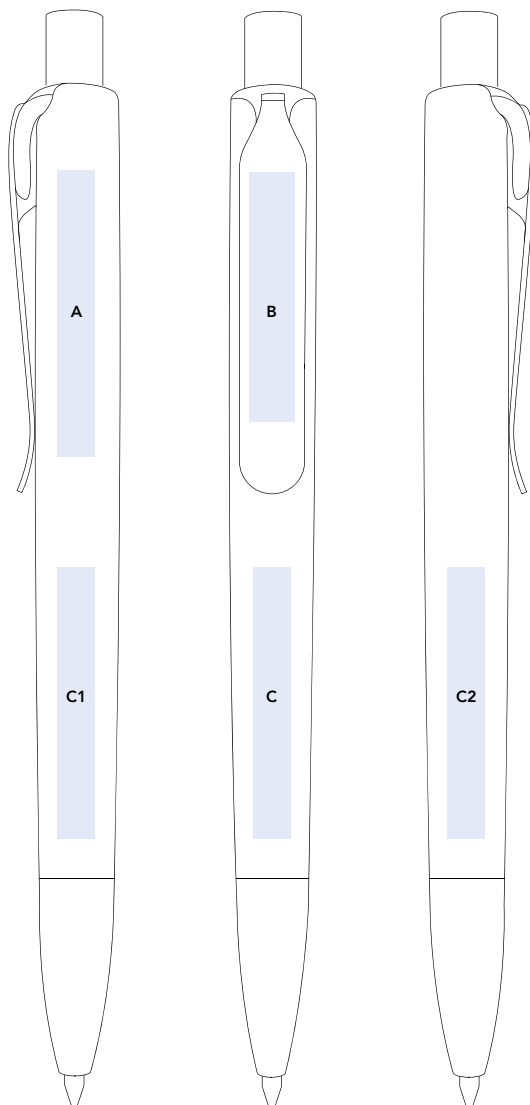

\*black, white or silver.

Evaluated upon request:

- Printing up to 2 colours
- PMS

Standard refill:  
Floating Ball® 1.0 mm.  
Discover other options  
on page 172.  
All Prodir pens are refillable.

Matt



DS8 PSM-S

DS8 PSM-S

DS8 PSM-S



Polished

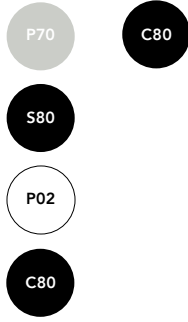
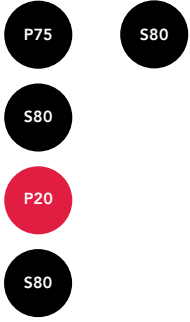

---

DS8 PSK-S

---

DS8 PSN-C

---

DS8 PSP-C



Soft Touch



---

DS8 PSR-S

---

DS8 PSR-S

---

DS8 PSR-S



surfaces  
and colours

**M - Matt**



M02 M07 M27 M58 M47 M70

**P - Polished**



P02• P10 P20 P55 P75

**R - Soft Touch**



R10 R21• R28 R50• R62• R54 R48• R70• R75•

• Also for mechanical pencil.

metal clip

**S - Satin finish metal**



S70 S02 S14 S75 S80

clip holder

**P - Polished**



P02 P07 P10 P20 P21 P28 P27 P55 P50 P62 P54 P58  
P48 P47 P70 P75

button option

**S - Satin finish metal**



S70 S02 S14 S75 S80

**C - Chrome finish metal**



C70 C02 C14 C75 C80

Plastic button is available in all DS8 colours. See page 143.

nose cone  
option

(not available  
for mechanical  
pencil)

**S - Satin finish metal**



S70 S14 S75 S80

**C - Chrome finish metal**

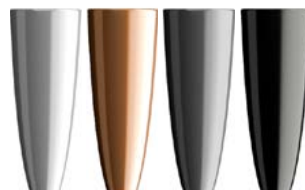

C70 C14 C75 C80



An asymmetrical shape that changes constantly to create the perfect balance between components. The tip is round, the button oval and the clip is wide and straight to give maximum visibility and importance to your brand. The DS9 Mix & Match offers a wealth of creative options: the colour range boasts bold tones, both for the body and the integrated button ring. A unique level of personalisation for a pen with a strong identity.



The Promotional  
Gift Award Winner

**DEU** Eine von rund bis zu oval verlaufene Form, die eine perfekte Balance zwischen dem Schaft und der Kappe erzeugt. Die abgerundete Spitze, der ovale Knopf und der breite, geradlinige Clip sorgen für ein Maximum an Sichtbarkeit und Aufmerksamkeit für Ihre Marke. Der DS9 Mix & Match bietet eine Vielzahl kreativer Gestaltungsmöglichkeiten. Die Farbpalette umfasst kräftige Töne für das Gehäuse und den integrierten Knopfring. Personalisierungsmöglichkeiten für einen Kugelschreiber mit einer starken Identität.

**FRA** Une forme asymétrique qui change constamment pour créer un équilibre parfait entre les différents éléments. La pointe est arrondie, le poussoir ovale et l'agrafe large et droite, tout cela donne une visibilité maximale à votre marque. Le DS9 Mix & Match offre une multitude d'options créatives : la gamme de couleurs se distingue par des tons audacieux, tant pour le corps que pour la bague de poussoir

intégré. Un niveau de personnalisation unique pour un stylo à forte identité.

**ESP** Una silueta asimétrica que cambia constantemente creando un equilibrio perfecto entre los componentes. La redondez de la punta, el botón de presión ovalado y el clip ancho y recto otorgan la máxima visibilidad y relevancia a su marca. El Mix & Match del DS9 brinda un amplio calidoscopio de opciones creativas: la gama de colores abarca tonos atrevidos, tanto para la carcasa como para el anillo integrado en el botón de presión. Un nivel único de personalización para un bolígrafo con una marcada identidad.

**ITA** Forme asimmetriche che cambiano di continuo, creando una perfetta armonia tra le parti. La punta è rotonda, il pulsante ovale, la clip ampia e diritta, perfetta per dare maggiore visibilità al brand di cui si fa portavoce e comunicarne l'importanza. Il Mix & Match della DS9 è ricco di opzioni

creative: la gamma colori è arricchita da tonalità audaci, sia per il corpo che per il ring integrato nel pulsante. Un livello di personalizzazione unico, per una penna con un'identità forte.

**CYR** Асимметричная форма, которая постоянно изменяется и создает идеальный баланс между компонентами. Наконечник закруглен, кнопка имеет овальную форму, а широкий зажим не изогнут. Все это делает вашу торговую марку более заметной и значимой. Сочетания по выбору, которые могут использоваться для ручки DS9, открывают широкое разнообразие возможностей для творчества. Цветовая палитра включает в себя глубокие тона, которые могут использоваться как для корпуса, так и для кольца кнопки. Уникальный уровень индивидуализации ручки при мощно выраженной идентичности.

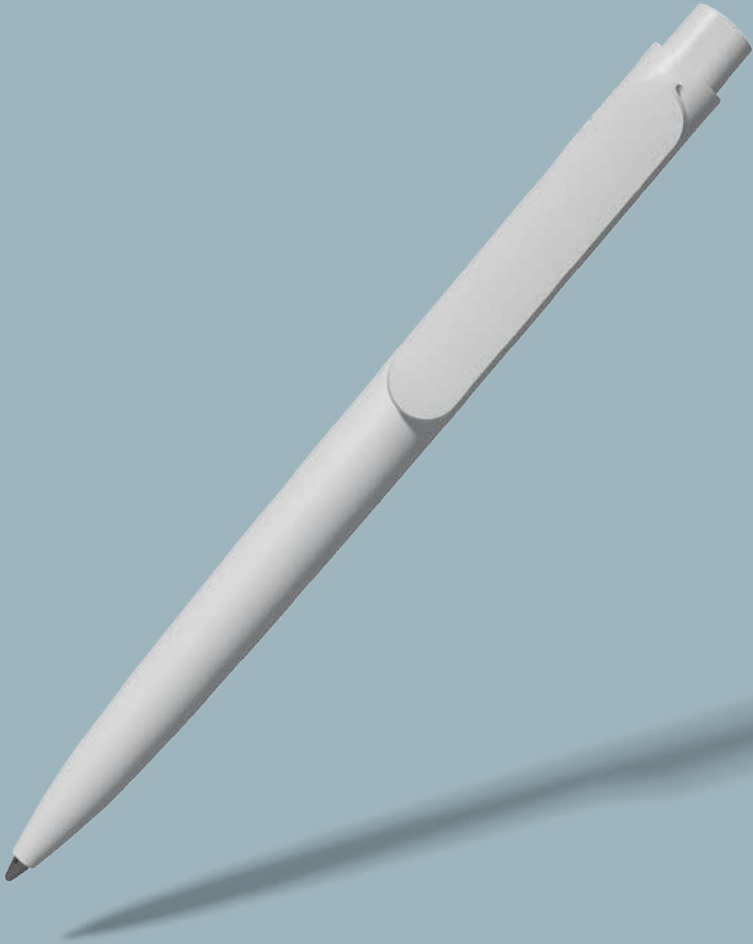

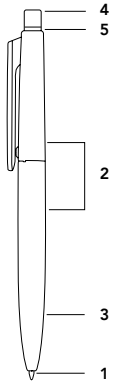

**product code**

**1 writing system**

**P** Push ball pen

**2 surface**

**F** Frosted with transparent clip

**M** Matt with polished clip

**3 nose cone**

**F** Frosted

**M** Matt

**S** Satin finish metal

**4 button**

**T** Transparent

**P** Polished

**Y** Galvanised satin

**Z** Galvanised chrome

**5 ring**

**T** Transparent

**P** Polished



Find out more on page 241

1	2	3		4	5
P	M	S	-	P	T

**print areas**

**A side cap**

35 x 4 mm  
1,38" x 0,16"  
1 colour

**B clip**

43 x 8 mm  
1,70" x 0,31"  
6 colours

**C body**

40 x 28 mm  
1,58" x 1,10"  
4 colours

**D back cap**

40 x 5 mm  
1,57" x 0,20"  
1 colour

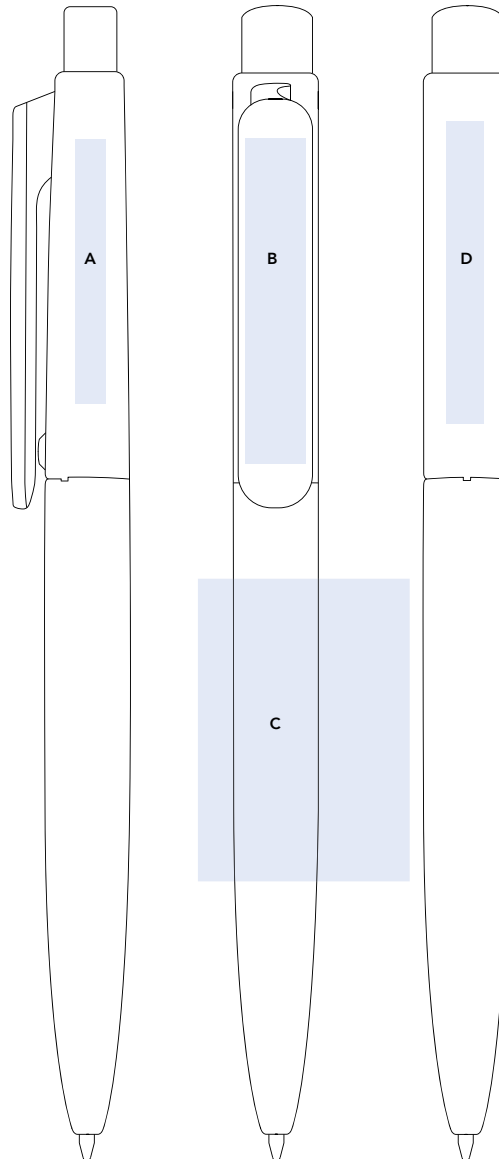

Standard Refill:  
Floating Ball® 1.0 mm.  
Discover other options  
on page 172.  
All Prodir pens are refillable.

surfaces  
and colours

**F - Frosted** with transparent clip



F01 F81 F21 F25 F50 F76

**M - Matt** with polished clip



M02 M05 M13 M20 M23 M27 M61 M60 M49 M77 M70 M75



M73 M90

button surfaces  
and colours

**T - Transparent**



T01 T81 T21 T25 T50 T76

**P - Polished**



P02 P05 P13 P20 P23 P27 P61 P60 P49 P77 P70 P75



P73 P90

ring option  
surfaces  
and colours\*

**T - Transparent**



T01 T81 T21 T25 T50 T76

**P - Polished**



P02 P05 P13 P20 P23

**P - Polished**



P27 P61 P60 P49 P77 P70 P75 P73 P90

\* Ring option not available with frosted pen and with galvanised satin, chrome and transparent button

button option

**Y - Galvanised satin**



Y70

**Z - Galvanised chrome**



Z70

nose cone option

**S - Satin finish metal**



T21

F21

Y70

F50

T76

F76

DS9 PFS-T



DS9 PFF-Y



DS9 PFF-T



Matt



DS9 PMM-P



DS9 PMM-PP



DS9 PMM-PP



P20

M20

T21

M02

P61

M61

DS9 PMM-P



DS9 PMS-T



DS9 PMS-P



- P13
- M13

- P75
- T25
- M75

- P73
- P02
- M49
- M02

DS9 PMM-P



DS9 PMM-PT



DS9 PMM-PP









## print areas

**total**

150,5 × 86,3 mm  
5,92" × 3,40"

**A side**

150 × 13,8 mm  
5,9" × 0,54"

**B front**

150,6 × 29 mm  
5,93" × 1,14"

**C side**

150 × 14,5 mm  
5,9" × 0,57"

**D back**

150,6 × 29 mm  
5,93" × 1,14"

**Personalisation:**

four-colour process  
(CMYK) plus 3 mm cut  
on the marked  
position.

Cardboard case  
for one writing instrument.

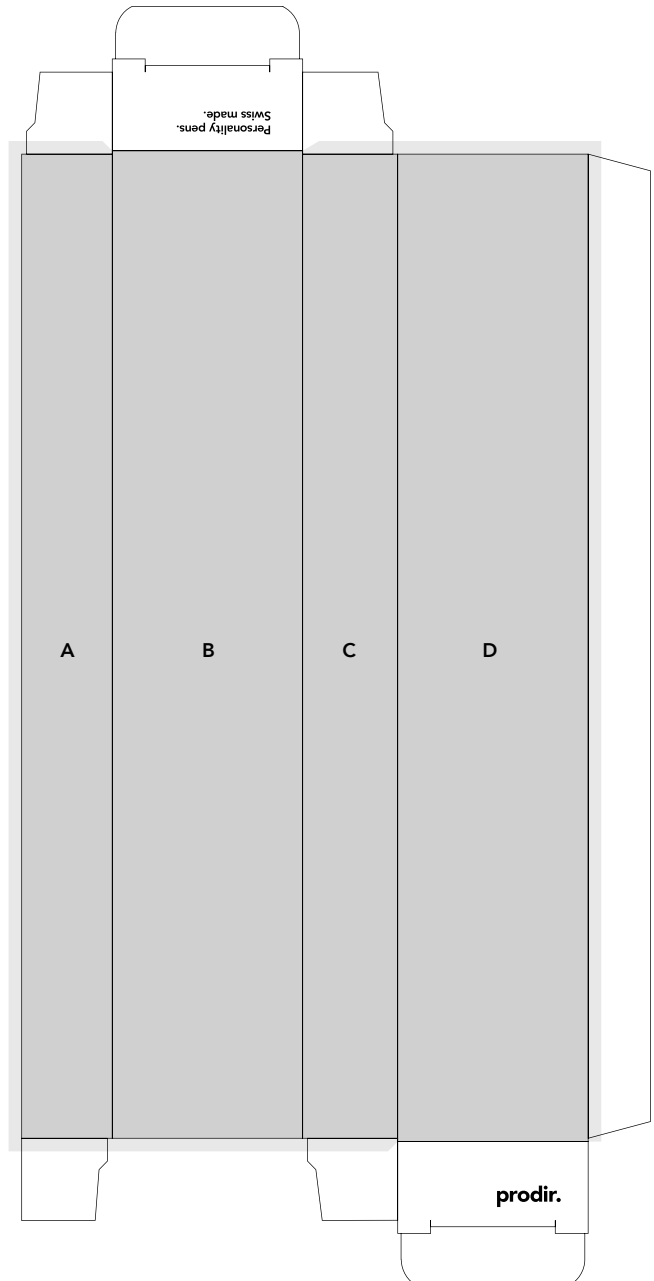



**print areas****total**

76 × 93 mm  
2,99" × 3,66"

**A side**

76 × 18 mm  
2,99" × 0,7"

**B front**

76 × 28 mm  
2,99" × 1,10"

**C side**

76 × 19 mm  
2,99" × 0,74"

**D back**

76 × 28 mm  
2,99" × 1,10"

**Personalisation:**

four-colour process  
(CMYK) plus 3 mm cut  
on the marked  
position.

Recycled PET case, not printable.  
With insert, for one or two writing instruments.

**Option: PS4 cardboard sleeve**

Refined cardboard sleeve that covers just a part of  
the transparent case PS4, leaving the printed  
clip on display.

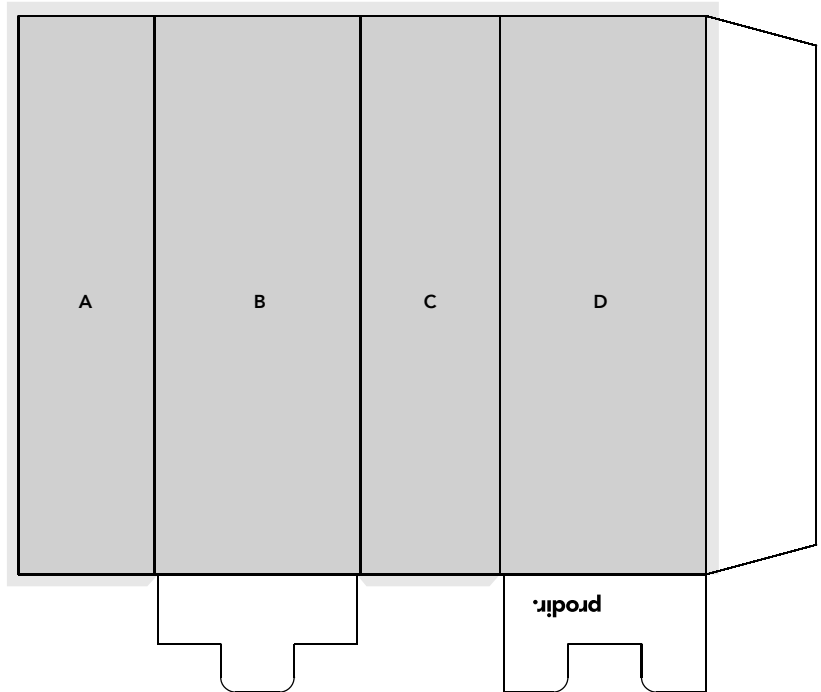



**print areas****A upper side**

60 × 15 mm  
2,36" × 0,59"

The printing area can be positioned across the entire surface of the markable area.

**Personalisation:**

Screen printing,  
single-colour or shiny  
transparent.

Black refined cardboard.  
Case with insert for two writing instruments,  
DS8 or QS.

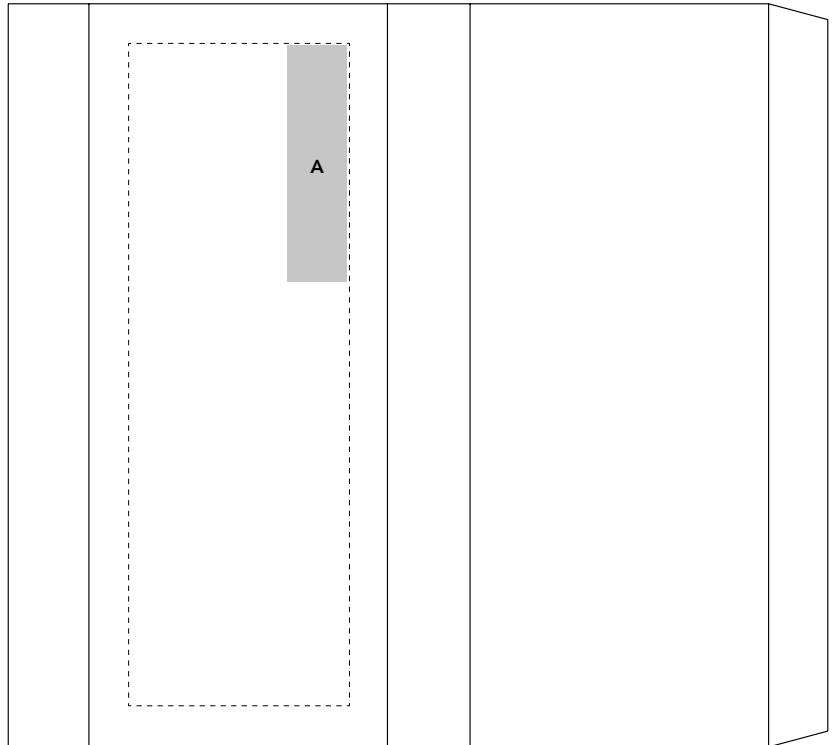





**print areas****total**

175 × 174 mm  
6,77" × 6,85"

**A side**

175 × 18 mm  
6,89" × 0,70"

**B front**

175 × 68 mm  
6,89" × 2,67"

**C side**

175 × 19 mm  
6,89" × 0,74"

**D back**

175 × 69 mm  
6,89" × 2,71"

**Personalisation:**

four-colour process  
(CMYK) plus 3 mm cut  
on the marked  
position.

Cardboard available in  
Soft Touch finish.

Soft foam case with elegant cardboard cover,  
for two writing instruments.

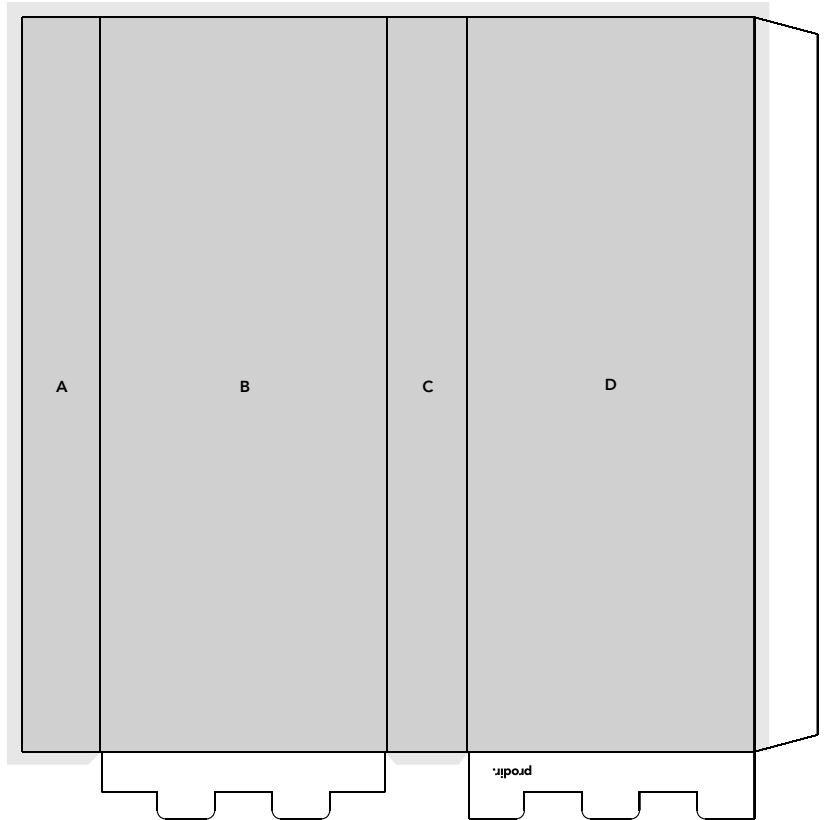







ENG

**Writing Systems**

Our refills deliver top writing comfort and perfect graphic style. We make a point of developing and producing them ourselves, as a writing system can only be as good and reliable as the precisely matched interplay of its components. It is easy to replace used refills for all Prodir models. So you can go on using our writing instruments for a long time – this is what they are designed for. All DS and QS models may be ordered with the refills Floating Ball, TechGlide and Gel. DS3 and DS8 can also be supplied as mechanical pencils.

DEU

**Schreibsysteme**

Hoher Schreibkomfort und ein perfektes Schriftbild zeichnen unsere Minen aus. Wir entwickeln und produzieren sie bewusst selbst, weil jedes Schreibsystem nur so gut und zuverlässig ist wie das genau aufeinander abgestimmte Zusammenspiel seiner Komponenten. Verbrauchte Minen lassen sich bei allen Prodir Modellen problemlos auswechseln. Damit Sie lange weiterschreiben können, denn dafür sind unsere Schreibgeräte ausgelegt. Alle DS und QS Modelle sind mit den Minen Floating Ball, TechGlide und Gel erhältlich. DS3 und DS8 können auch als Druckbleistift geliefert werden.

FRA

**Systèmes d'écriture**

Un confort d'écriture élevée et un tracé parfait caractérisent nos recharges. Nous les développons et les produisons volontairement nous-mêmes car la qualité et la fiabilité d'un instrument d'écriture dépendent de l'harmonie précise entre ses différents éléments. Une fois épuisées, les recharges peuvent être remplacées, sur tous les modèles Prodir. Afin que vous puissiez continuer à écrire longtemps, ce pourquoi nos instruments d'écriture ont été conçus. Toutes nos références DS et QS sont rechar geables en Floating Ball, TechGlide et Gel. Le DS3 et le DS8 sont également disponibles sous la forme d'un porte-mine.



Floating Ball®

1.0 mm

Standard



Floating Ball®

1.4 mm

Option



ESP

**Sistemas de escritura**

Una gran comodidad al escribir y una escritura perfecta son lo que caracteriza a nuestras minas. Las desarrollamos y las producimos nosotros mismos, fruto de una decisión plenamente consciente, porque cada sistema de escritura solamente puede ser tan bueno y tan fiable como lo sea la combinación perfectamente coordinada de sus componentes. Las minas gastadas se pueden cambiar sin problema en todos los modelos Prodir. Para que usted pueda continuar escribiendo por mucho tiempo, pues para eso están diseñados nuestros instrumentos de escritura. Para todos los modelos DS y QS es posible pedir minas Floating Ball, TechGlide y Gel. El DS3 y el DS8 también están disponibles como portaminas.

ITA

**Sistemi di scrittura**

I nostri refill si distinguono per un elevato comfort di scrittura e un tratto perfetto. Non a caso li progettiamo e realizziamo direttamente, perché ogni sistema funziona ed è affidabile solo grazie al perfetto connubio tra i singoli componenti. I refill esauriti si possono sostituire senza problemi in tutti i modelli Prodir. Così potrai scrivere a lungo, perché i nostri strumenti di scrittura sono progettati per questo. In tutti i modelli DS e QS è possibile utilizzare refill Floating Ball, TechGlide e Gel. La DS3 e la DS8 sono disponibili anche come portamine.

CYR

**Системы письма**

Наши стержни отличаются максимальным комфортом при письме и превосходным характером письма. Мы осознанно сами разрабатываем и производим их, ведь любая система письма хороша и надежна лишь настолько, насколько слаженным является взаимодействие ее компонентов. Исползованные стержни во всех моделях Prodir можно без проблем заменить, чтобы продолжить писать, ведь именно для этого и предназначены наши письменные приборы. Модели DS и QS можно заказать на выбор со стержнем Floating ball, TechGlide или целевым. DS3 и DS8 также выпускаются в виде механического карандаша.

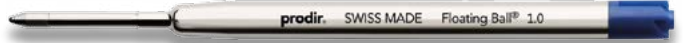

Floating Ball® 1.0 mm Option ●●

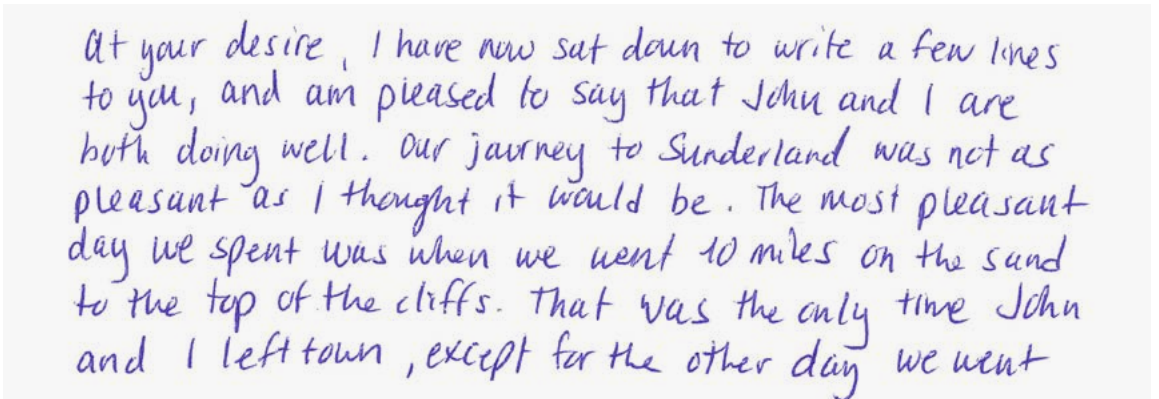

TechGlide® 1.0 mm Option ●●

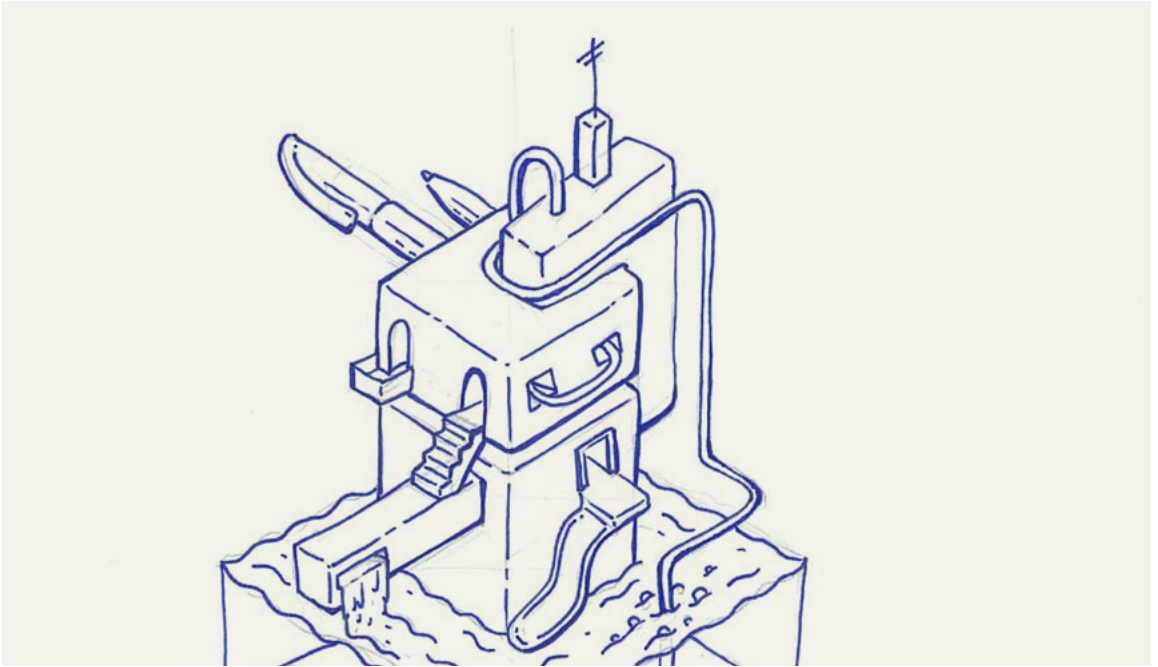

Gel Superdry®

0.7 mm

Option



Madame, Monsieur,

Je tiens à vous remercier vivement, à travers cette lettre, du service de personnalisation de stylos que vous m'avez fourni. J'ai constaté que, comme à votre habitude, tout ce que vous avez fait était de très bonne qualité. Vous avez grandement contribué, par votre expertise, à ce que le déroulement de la personnalisation se



Gel pigmented

0.5 mm

Option



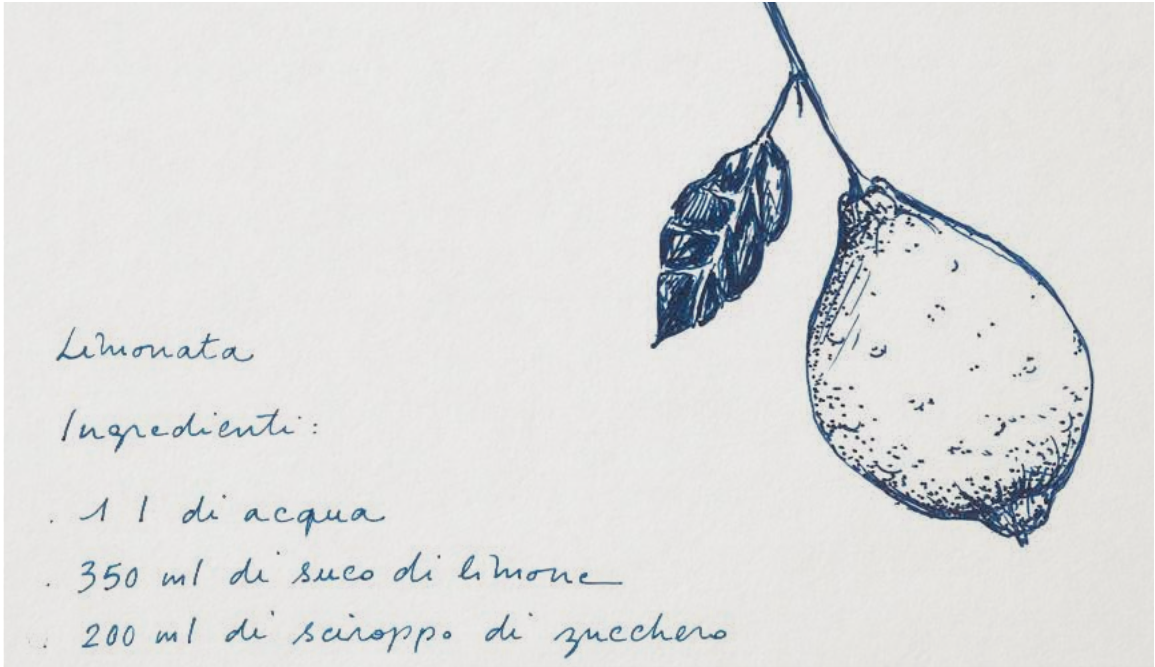

Gel Dark Blue

0.6 mm

Option



HB lead

0.7 mm

Option



## ENG

## Ballpoint Pens

## Floating Ball®

The standard refill for all Prodir writing instruments - for a consistent graphic style and long-term writing pleasure.

Large-capacity plastic refill with 1 mm tungsten carbide ball in a special copper alloy, medium viscosity ink, Blue or Black, ISO 12757-1/2, documentary proof.

## Options

- Large-capacity metal refill for even higher writing performance and more heft
- 1.4 mm tip for an even softer writing experience
- Red and green available on request

## TechGlide®

Premium refill with low viscosity ink for maximum writing comfort and precise lines for an extra-soft writing experience.

Large-capacity metal refill with 1 mm tungsten carbide ball in an anti-corrosion stainless steel tip, low viscosity ink, Blue or Black, ISO 12757-1.

## Gel pens

## Gel SuperDry®

Quicker-drying than traditional gel refills, smooth writing experience, consistent lines and precise graphic style.

Plastic refill with 0.7 mm tungsten carbide ball in an anti-corrosion stainless steel tip, water-based ink, Blue or Black, ISO 27668-1.

## Gel Dark Blue

Gel refill with a fine tip, smooth writing experience, consistent lines and precise graphic style.

Plastic refill with 0.6 mm tungsten carbide ball in an anti-corrosion stainless steel tip, water-based ink, dark Blue, ISO 27668-1.

## Gel Pigmented

Gel refill with extra-fine tip and pigmented ink, smooth writing experience, consistent lines and precise graphic style, ideal for Asian writing styles. Plastic refill with extra-fine 0.5 mm tungsten carbide ball in an anti-corrosion stainless steel tip, water-based pigmented ink, Blue and Black, ISO 27668-1/2, documentary proof.

## Mechanical Pencils

Mechanical pencil with integral eraser.

Robust double-push mechanism with retractable stainless steel tip, medium hard 0.7 mm HB lead. Available as an option for DS3 and DS8 models.

## DEU

## Kugelschreiber

## Floating Ball®

Standardmine aller Prodir Schreibgeräte, für ein gleichmäßiges Schriftbild und langen Schreibgenuss.

Kunststoff-Grossraummine mit 1.0 mm Wolframcarbidge-Kugel in Neusilberspitze, Tintenpaste mittlerer Viskosität, Schreibfarben Blau oder Schwarz, ISO Normen 12757-1/2, dokumentenecht.

## Optionen

- Metall-Grossraummine für noch mehr Schreibleistung, höheres Gewicht
- 1.4 mm Spitze für ein noch weiches Schreibgefühl
- Schreibfarben Rot und Grün auf Anfrage

## TechGlide®

Premium Mine mit niederviskoser Tintenpaste mit maximalem Schreibkomfort und präziser Linienführung für ein extra weiches Schreibgefühl. Metall-Grossraummine mit 1.0 mm Wolframcarbidge-Kugel in korrosionsresistenter Edelstahlspitze, niederviskose Tintenpaste, Schreibfarben Blau oder Schwarz, ISO Norm 12757-1.

## Gelschreiber

## Gel SuperDry®

Schneller trocknend als herkömmliche Gel-Minen, gleitendes Schreibgefühl, konstante Linienführung und intensives Schriftbild.

Kunststoff-Mine mit 0.7 mm Wolframcarbidge-Kugel in korrosionsresistenter Edelstahlspitze, wasserbasierte Tinte, Schreibfarben Blau oder Schwarz, ISO Norm 27668-1.

## Gel Dark Blue

Gel-Mine mit feiner Spitze, gleitendes Schreibgefühl, konstante Linienführung und intensives Schriftbild. Kunststoff-Mine mit 0.6 mm Wolframcarbidge-Kugel in korrosionsresistenter Edelstahlspitze, wasserbasierte Tinte, Schreibfarbe Dunkelblau, ISO Norm 27668-1.

## Gel Pigmented

Gel-Mine mit extrafeiner Spitze und pigmentierter Tinte, gleitendes Gel-Schreibgefühl, konstante Linienführung und intensives Schriftbild, ideal für asiatische Schreibgewohnheiten. Kunststoff-Mine mit extrafeiner 0.5 mm Wolframcarbidge-Kugel in korrosionsresistenter Edelstahlspitze, pigmentierte Tinte auf Wasserbasis, Schreibfarben Blau und Schwarz, ISO Normen 27668-1/2, dokumentenecht.

## Druckbleistifte

Mechanischer Bleistift mit integriertem Radiergummi. Stabile Doppeldruckmechanik mit versenkbarer Edelstahlspitze, mittelharte 0.7 mm HB Mine. Als Option für die Modelle DS3 und DS8.

## FRA

## Stylos à bille

## Floating Ball®

La recharge standard de tous les instruments d'écriture Prodir, pour un tracé régulier et un long plaisir d'écrire.

Recharge plastique grande capacité, avec bille 1,0 mm en carbure de tungstène et pointe en alliage de cuivre spécial, encre de viscosité moyenne, couleurs d'encre bleu et noir, conforme aux normes ISO 12757-1/2, convient pour utilisation documentaire.

## Options

- Recharge métal grande capacité pour une performance d'écriture encore supérieure, poids plus élevé
- Pointe 1,4 mm pour une sensation d'écriture encore plus douce
- Couleur d'encre rouge et vert sur demande

## TechGlide®

Recharge premium à encre basse viscosité, confort d'écriture maximum et tracé très précis pour une sensation d'écriture extra douce.

Recharge métal grande capacité, avec bille 1,0 mm en carbure de tungstène et pointe acier inoxydable résistante à la corrosion, encre de basse viscosité, couleurs d'encre bleu et noir, conforme à la norme ISO 12757-1.

## Stylos gel

## Gel SuperDry®

Sèche plus rapidement que les recharges gel courantes, sensation d'écriture très souple, tracé régulier et ligne intense.

Recharge plastique, avec bille 0,7 mm en carbure de tungstène et pointe acier inoxydable résistante à la corrosion, encre à base d'eau, couleurs d'encre bleu et noir, conforme à la norme ISO 27668-1.

## Gel Dark Blue

Recharge gel à pointe fine, sensation d'écriture très souple, tracé régulier et ligne intense. Recharge plastique, avec bille 0,6 mm en carbure de tungstène et pointe acier inoxydable résistante à la corrosion, encre à base d'eau, couleurs d'encre bleu foncé, conforme à la norme ISO 27668-1.

## Gel Pigmented

Recharge gel à pointe extra fine, à encre pigmentée, sensation d'écriture très souple du gel, tracé régulier et ligne intense, idéale pour les habitudes d'écriture asiatiques.

Recharge plastique, avec bille extra fine 0,5 mm en carbure de tungstène et pointe acier inoxydable résistante à la corrosion, encre pigmentée à base d'eau, couleurs d'encre bleu et noir, conforme aux normes ISO 27668-1/2, pour utilisation documentaire.

## Porte-mine

Porte-mine mécanique avec gomme intégrée. Mécanisme robuste à double pression avec pointe acier inoxydable escamotable, mines de dureté moyenne HB 0,7 mm. En option pour les modèles DS3 et DS8.

ESP

## Bolígrafos

### Floating Ball®

La mina estándar de todos los bolígrafos Prodir, que proporciona una escritura uniforme y permite disfrutar escribiendo por mucho tiempo.

Mina de gran capacidad de plástico con bola de carburo de wolframio de 1.0 mm dentro de una punta de alpaca, pasta de tinta de viscosidad media de color azul o negro, normas ISO 12757-1/2, indeleble.

#### Opciones

- Mina de gran capacidad de metal, que tarda más en gastarse y aporta un peso mayor
- Punta de 1,4 mm, que proporciona una sensación aún más suave al escribir
- Disponible en tinta roja y verde si así nos lo solicita

### TechGlide®

Mina premium con pasta de tinta de baja viscosidad, que consigue un trazo preciso y proporciona la máxima comodidad y una extra sensación extrasuave al escribir.

Mina de gran capacidad de metal con bola de carburo de wolframio de 1.0 mm dentro de una punta de acero fino resistente a la corrosión, pasta de tinta de baja viscosidad de color azul o negro, norma ISO 12757-1.

## Bolígrafos de gel

### Gel SuperDry®

Seca más rápidamente que las minas de gel convencionales, sensación deslizante al escribir, trazo constante y escritura intensa.

Mina de plástico con bola de carburo de wolframio de 0,7 mm dentro de una punta de acero fino resistente a la corrosión, tinta a base de agua de color azul o negro, norma ISO 27668-1.

### Gel Dark Blue

Mina de gel con una punta fina, sensación deslizante al escribir, trazo constante y una escritura intensa. Mina de plástico con bola de carburo de wolframio de 0,6 mm dentro de una punta de acero fino resistente a la corrosión, tinta a base de agua de color azul oscuro, norma ISO 27668-1.

### Gel Pigmented

Mina de gel con punta extrafina y tinta pigmentada, sensación deslizante al escribir con gel, trazo constante e intenso, ideal para la escritura en lenguas asiáticas.

Mina de plástico con bola de carburo de wolframio extrafina de 0,5 mm dentro de una punta de acero fino resistente a la corrosión, tinta pigmentada a base de agua de color azul o negro, normas ISO 27668-1/2, indeleble.

## Portaminas

Lápiz mecánico con goma de borrar integrada. Mecanismo de doble presión robusto con punta de acero inoxidable retráctil, mina HB de 0,7 mm de dureza media. Disponible como opción para los modelos DS3 y DS8.

ITA

## Penne a sfera

### Floating Ball®

Refill standard per tutti gli strumenti di scrittura Prodir, per un tratto regolare e un prolungato piacere di scrivere.

Capiente refill in plastica con sfera in carburo di tungsteno da 1,0 mm in una punta in argenteone, inchiostro di media viscosità, disponibile in blu o nero, indicato per documenti secondo le norme ISO 12757-1/2.

#### Opzioni

- Capiente refill in metallo per una durata e un peso maggiori
- Punta da 1,4 mm per una sensazione di scrittura più morbida
- Inchiostro rosso e verde disponibili su richiesta

### TechGlide®

Refill premium con inchiostro a bassa viscosità, massimo comfort e tratto preciso per una sensazione di scrittura extra-soft.

Capiente refill in metallo con sfera in carburo di tungsteno da 1,0 mm in una punta di acciaio inox resistente alla corrosione, inchiostro a bassa viscosità, disponibile in blu o nero, normativa ISO 12757-1.

## Penne gel

### Gel SuperDry®

Asciugatura più rapida dei refill gel tradizionali, sensazione di scrittura scorrevole, tratto costante e intenso.

Refill in plastica con sfera in carburo di tungsteno da 0,7 mm in una punta di acciaio inox resistente alla corrosione, inchiostro a base d'acqua, disponibile in blu o nero, normativa ISO 27668-1.

### Gel Dark Blue

Refill gel con punta sottile, sensazione di scrittura scorrevole, tratto costante e intenso. Refill in plastica con sfera in carburo di tungsteno da 0,6 mm in una punta di acciaio inox resistente alla corrosione, inchiostro a base d'acqua, disponibile in blu scuro, normativa ISO 27668-1.

### Gel Pigmented

Refill gel con punta ultrasottile e inchiostro pigmentato, scorrevolezza tipica del gel, tratto costante e intenso, ideale per le consuetudini di scrittura asiatiche.

Refill in plastica con sfera ultrasottile in carburo di tungsteno da 0,5 mm in una punta di acciaio inox resistente alla corrosione, inchiostro pigmentato a base d'acqua, disponibile in blu o nero, indicata per documenti secondo le norme ISO 27668-1/2.

## Portamine

Matita meccanica con gomma integrata. Stabile meccanismo a doppia pressione con punta retrattile in acciaio inox, mina HB 0,7 mm di media durezza. Opzione disponibile per i modelli DS3 e DS8.

CYR

## Шариковые ручки

### Floating Ball®

Стандартный стержень для всех письменных приборов Prodir, обеспечивающий равномерный характер письма и длительное наслаждение от письма. Пластмассовый стержень большого объема с шариком из карбида вольфрама диаметром 1,0 мм в новом серебристом наконечнике с пастой средней вязкости синего или черного цвета, стандарты ISO 12757-1/2, может использоваться для архивных документов долговременного хранения.

#### Опции

- Металлический стержень большого объема для еще большей производительности письма, утяжеленный.
- Кончик диаметром 1,4 мм для еще более мягкого и плавного письма.
- Паста красного и зеленого цвета по запросу.

### TechGlide®

Стержень премиум-класса с пастой низкой вязкости с максимальным комфортом при письме и точной линией для очень мягкого и плавного письма.

Металлический стержень большого объема с шариком из карбида вольфрама диаметром 1,0 мм в коррозионностойком наконечнике из высококачественной стали с пастой низкой вязкости синего или черного цвета, стандарт ISO 12757-1.

## Гелевые ручки

### Gel SuperDry®

Паста впитывается намного быстрее, чем у традиционных гелевых стержней, плавное письмо, непрерывная линия и яркий след. Пластмассовый стержень с шариком из карбида вольфрама диаметром 0,7 мм в коррозионностойком наконечнике из высококачественной стали с пастой на водной основе синего или черного цвета, стандарт ISO 27668-1.

### Gel Dark Blue

Гелевый стержень с тонким кончиком, плавное письмо, непрерывная линия и яркий след. Пластмассовый стержень с шариком из карбида вольфрама диаметром 0,6 мм в коррозионностойком наконечнике из высококачественной стали с пастой на водной основе темно-синего цвета, стандарт ISO 27668-1.

### Gel Pigmented

Гелевый стержень с очень тонким кончиком и пигментированной пастой, плавное письмо, непрерывная линия и яркий след, идеальный вариант для письма в азиатском стиле. Пластмассовый стержень с шариком из карбида вольфрама диаметром 0,5 мм в коррозионностойком наконечнике из высококачественной стали с пастой на водной основе синего или черного цвета, стандарт ISO 27668-1/2, может использоваться для архивных документов долговременного хранения.

## Механический карандаш

Механический карандаш с ластиком. двойной нажимной механизм с убирающимся прочный двойной из высококачественной стали, грифель средней твердости диаметром 0,7 мм. В качестве опции для моделей DS3 и DS8.







---

DS1 TFF

---

DS2 PFF-M

---

DS3 TFF

---

DS3.1 TFF

---

DS5 TFF-M

---

DS7 PFF-F



T01

F50

F01

F01

T01

T01

T01

T01

---

DS9 PFF-T

---

DS2 PFF-F

---

DS1 TTT

---

DS3 TTT

---

DS3.1 TTC

---

DS5 TTT



F01

T01

DS7 PTT-F



M02

DS1 TMM



M02

M02

DS2 PMM-M



X35

M02

DS3 TMM-X



M02

DS5 TMM



M02

M02

DS7 PMS-M



S70

P02

S70

M02

P02

M02

P02

M02

P02

M02

X01

P02

T45

P02

DS8 PSM-S

DS9 PMM-P

QS01 PMP

QS20 PMP

DS1 TPP-X

DS2 PPP-T







DS3 TPP

DNA PPP-P

DS5 TPP

DS6 PPP-P

DS7 PPP-M

DS8 PPP-S



P02

P02

DS8 PPP



P02

DS3.1 TPP



P02

P02

QS04 PPP



B02

DS3 TBB



T06

V03

DS2 PVV-T



V03

DS3 TVS





DS5 TVV

DS7 PVV-M

DS3 TBB

DS9 PFF-T

DS9 PMM-T

QS01 PMP





QS20 PMP

QS01 PRP

QS20 PRP

DS3.1 TPP

DS8 PSM-C

DS3.1 TTT





---

DS1 TFF-X

---

DS3 TFF

---

DS5 TFF

---

DS7 PFF-F

---

DS2 PTT-T

---

DS3 TTT



T06

F06

T06

P06

P06

P06

P06

T06

P06

---

DS5 TTC

---

DS7 PTT-F

---

DS1 TPP

---

DS3 TPP

---

DS5 TPP

---

DS6 PPP-P





QS04 PPT

QS04 PRT

QS01 PMT

QS20 PMT-S

QS01 PRT

QS20 PRT



P90

F10

F10

X52

M90

F10

F10

F10

F10

T10

---

DS9 PMM-P

---

DS2 PFF-F

---

DS3 TFF

---

DS5 TFF

---

DS7 PFF-F

---

DS1 TTT-X







---

DS2 PTT-T

---

DS3 TTT

---

DS3.1 TTT

---

DS5 TTT

---

DS7 PTT-M

---

DS1 TPP





---

DS2 PPP-P

---

DS3 TPP

---

DS5 TPP

---

DS7 PPP-M

---

DS6 PPP-P

---

DS8 PPP





DS3 TRR

DS6 PRR-P

DS8 PRR

DS3 TBB

DS9 PMM-P

QS01 PMP



P29

P29

P29

X01

F20

M29

R29

R29

F20

F20

F20

QS20 PMP

QS01 PRP

QS20 PRP

DS1 TFF-X

DS2 PFF-F

DS3 TFF







---

DS5 TPP

---

QS04 PPT

---

DS7 PPP-M

---

DS8 PPP

---

DS9 PMM-P

---

QS01 PMT



T20

T20

S70

T20

T20

F21

M20

R20

R20

R20

F21

F21

QS20 PMT

QS04 PRT

QS01 PRT-S

QS20 PRT

DS5 TFF

DS7 PFF-F



T21

F21

T21

F21

T21

P21

T21

P21

R21

Y70

T21

R21

DS9 PFF-T

DS5 TTC

DS7 PTT-F

DS6 PPP-P

DS3 TRR

DS6 PRR-Y







---

DS8 PRR

---

DS3 TBB

---

DS3.1 TFS

---

DS3.1 TTT

---

DS2 PFF-F

---

DS3 TFF-X



T25

T25

P23

T25

X47

F25

T25

T25

T25

P23

M23

DS9 PFF-T

DS2 PTT-T

DS3 TTT

DS3.1 TTT

DS6 PPP-P

DS1 TMM-X



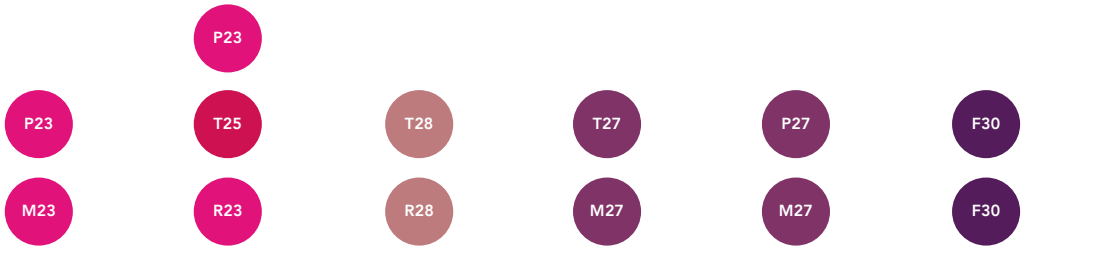

DS9 PMM-P

DS6 PRR-P

DS8 PRR

DS8 PMM

DS9 PMM-P

DS2 PFF-F



F30

F30

M10

F30

T30

T30

T30

T30

DS3 TFF

DS5 TFF

DS7 PFF-M

DS2 PTT-T

DS3 TTT

DS3.1 TTT





---

DS5 TTT

---

DS7 PTT-F

---

DS3.1 TPP

---

DS9 PMM-P

---

DNA PPP-P

---

DS1 TFF



P63

P63

P63

F50

F50

F50

F50

M41

F50

T50

F50

DS6 PPP-P

DS2 PFF-F

DS3 TFF

DS5 TFF

DS7 PFF-M

DS9 PFF-T





DS1 TTT

DS2 PTT-T

DS3 TTT-X

DS5 TTC

DS7 PTT-F

DS3 TRR



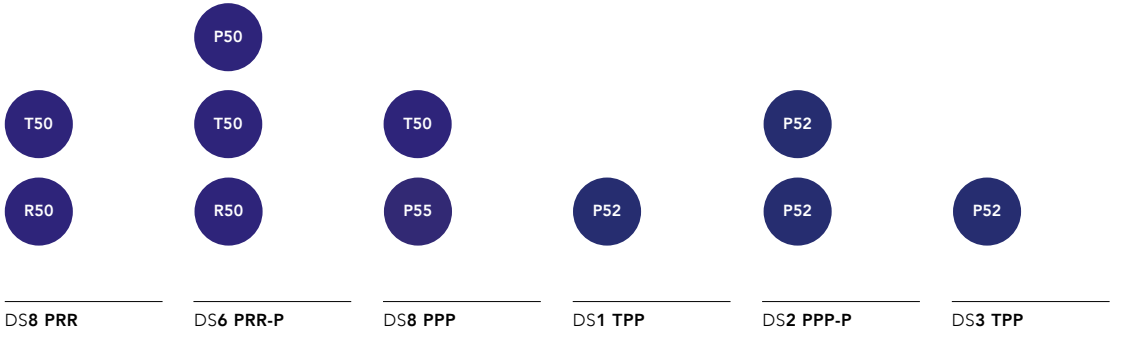





DS5 TPP

QS04 PPT

DS6 PPP

DS3.1 TTT

QS01 PMT

DNA PPP-P



S70

T62

T62

T62

T62

M62

R62

R62

R62

V51

V51

QS20 PMT

QS04 PRT-S

QS01 PRT

QS20 PRT

DS3 TVV

DS5 TVV





---

DS3 TBB

---

DS9 PMM-P

---

DS8 PRR

---

DS1 TFF

---

DS2 PFF-T

---

DS3 TFF



T55

T55

T55

X70

T55

T55

P10

F51

F51

F51

DS1 TTC

DS2 PTT-T

DS3 TTT-X

DS3.1 TTT

DS5 TFF-P

DS7 PFF-F



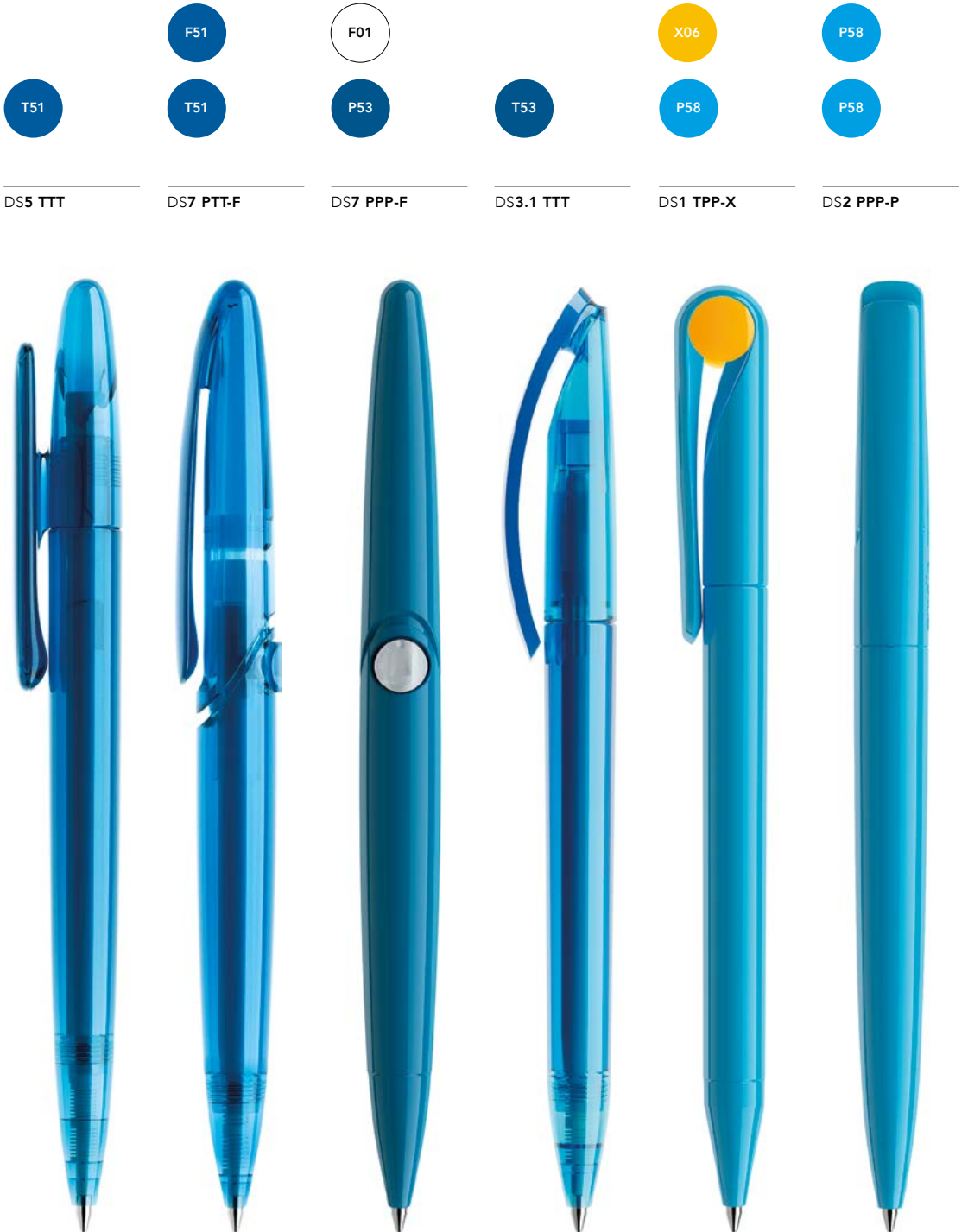



DS3 TPP

DS5 TPP

DS6 PPP-P

DS8 PSH-S

QS01 PMT

QS20 PMT





DS8 PMM

DS6 PRR-P

QS01 PRT

QS20 PRT

DS9 PMM-P

DS2 PMM-M



T36

F35

M02

F35

F01

F35

F35

T35

Z70

F35

DS3.1 TTT

DS3 TFF

DS5 TFF-M

DS7 PFF-F

DS2 PTT-F

DS2 PFF-Z







DS3 TTT

DS5 TTT

DS7 PTT-F

DS5 TFF

DS7 PFF-F

DS5 TTC



F41

M02

T45

P41

M41

T66

T41

F45

F45

P41

P41

M66

DS7 PTT-F

DS2 PFF-M

DS2 PFF-T

DS2 PPP-P

DS7 PPC-M

QS01 PMT





QS20 PMT

QS04 PPT

QS04 PRT

QS01 PRT

QS20 PRT-S

DS6 PPP-P





DS6 PRR-P

DS8 PSR-S

DS3.1 TTT

DS6 PPP-P

DS6 PRR-P

DS8 PMM-C





---

DS1 TTC

---

DS3 TFF

---

DS3 TTT

---

DS3 TBB

---

QS01 PMT

---

QS20 PMT



T67

S70

T67

T01

M41

R67

R67

F42

F42

F42

F42

QS01 PRT

QS20 PRT-S

DS2 PFF-T

DS3 TFF

DS5 TFF

DS7 PFF-M



T42

T42

T42

T42

F42

T42

M49

P13

P02

M49

DS2 PTT-T

DS3 TTT

DS5 TTT

DS7 PTT-F

DS1 TMM

DS9 PMM-PP



- P79
- T79
- R79

- Z70
- T79
- P79

- P70
- M77

- P77
- M77

- S70
- P77
- M77

- P77

DS6 PRR-P

DS6 PPP-Z

DS9 PMM-P

QS01 PMP

QS20 PMP-S

DS3.1 TPP







QS01 PMP

QS20 PRP

DS2 PVV-M

DS3 TVV

DS5 TVV

DS7 PVV-M



Y70

A70

A70

A70

M75

A70

M70

T76

M70

---

DS2 PAA-Y

---

DS3 TAA

---

DS5 TAA

---

DS7 PAA-M

---

DS1 TMM

---

DS8 PMM



S70

P70

P70

S70

F76

F76

M70

R70

F76

F76

F76

DS9 PMM-P

DS8 MSR-S

DNA PPP-P

DS2 PFF-F

DS5 TFF

DS7 PFF-F



T76

F76

M74

T76

T76

T76

P74

V75

V75

---

DS2 PTT-T

---

DS5 TTT

---

DS7 PTT-F

---

DS7 PPP-M

---

DS3 TVV

---

DS5 TVV





---

DS1 TFF

---

DS3 TFF

---

DS3.1 TFF

---

DS3 TTT

---

DS3.1 TTT

---

DS1 TPP-X



P75

P75

DS2 PPP-P

P75

DS3 TPP

P75

DS3.1 TPP

P75

DS5 TPP

P75

P75

P75

DS6 PPP-P

M74

P75

DS7 PPP-M



C70

P75

P75

P75

P75

X75

M75

M75

M75

M75

M75

DS8 PPP-C

QS04 PPP

DS1 TMM-X

DS2 PMM-M

DS3 TMM

DS5 TMM



M75

P75

P75

S70

P75

P75

M75

M75

M75

M75

M75

DS7 PMM-M

DS9 PMM-P

QS01 PMP

QS03 PMP-S

QS20 PMP

DNA PPP-P





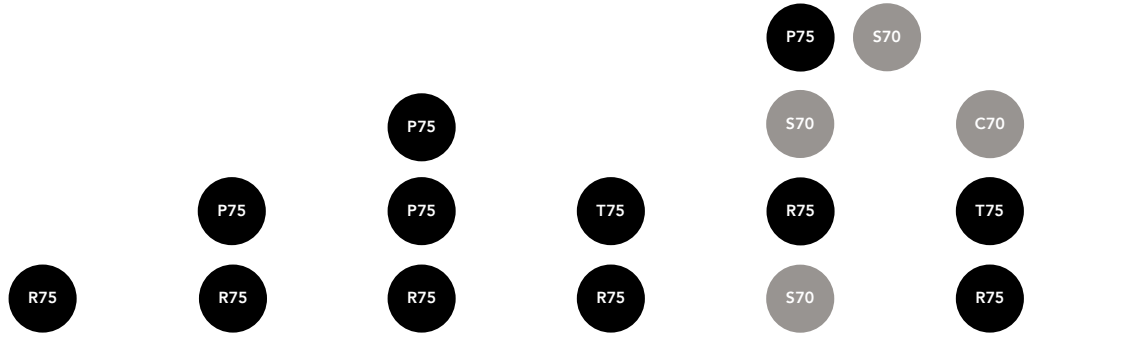

DS3 TRR

DS5 TRR-P

DS6 PRR-P

DS8 PRR

DS8 PSQ-S

DS8 MRR-C



P75

P75

P75

P75

R75

R75

R75

R75

B75

---

QS01 PRP

---

QS04 PRP

---

QS03 PRP

---

QS20 PRP

---

DS3 TBB





DS1 TFS-X

DS2 PTT-P

QS01 PMT-C

DS1 TMM

DS9 PMM-PP

DS5 TPC-P





DS7 PPP-M



DS6 PPP-P



DS8 PPP-P



QS01 PRP-S



DS3 TTT-X



DS7 PFF-M



P02

C70

T50

X01

P02

X01

T01

P06

R09

P10

M29

F20

R21

DS5 TPC-P

QS20 PRT-C

DS1 TPC-X

QS01 PMP-C

DS1 TFF-X

DS8 PRR



C70

T76

R28

P02

T41

X10

F42

M02

T35

T62

M58

X52

T55

DS8 PRR-C

DS5 TTC-P

DS3 TFF-X

DS7 PTT-M

QS20 PMT

DS1 TTC-X





DS3 TVV-X

DS6 PRC-P

DS3 TVV-X

DS8 PSP-C

QS03 PRP

DS9 PFF-P



P79

P02

R79

F50

A70

S80

P70

S70

R70

T25

V70

X35

V03

P10

V03

DS6 PRR-P

DS2 PAA-F

DS8 PSR-S

DS2 PVS-T

DS3 TVV-X

DS2 PVS-P





**ENG****Special colours**

In the unlikely event that the colour you're looking for is not part of our standard range, we look forward to mixing it for you – with Pantone, HKS and RAL colour scales. DS3 Biotic: the result is matched to your Pantone colour as closely as technically possible.

**ESP****Colores especiales**

Si se da la desafortunada circunstancia de que, pese a la amplitud de nuestra gama de colores estándar, usted no encuentra el color que busca, estaremos encantados de crearlo a su medida tomando como referencia las gamas cromáticas Pantone, HKS y RAL. DS3 Biotic: el resultado se ajustará a su color Pantone tanto como sea posible técnicamente.

**DEU****Sonderfarben**

Sollten Sie unter unseren vielen Standardfarben wider Erwarten nicht die Farbe Ihrer Wahl finden, mischen wir sie natürlich gerne für Sie – nach den Skalen Pantone, HKS und RAL. DS3 Biotic: das Ergebnis ist Ihrer Pantone-Farbe so nah wie technisch möglich.

**ITA****Colori speciali**

Se per uno sfortunato caso non riusciste a trovare il colore che cercate all'interno del nostro vasto assortimento, saremo lieti di crearlo su misura per voi utilizzando le gamme cromatiche Pantone, HKS e RAL. DS3 Biotic: il risultato, nei limiti tecnici, si avvicinerà il più possibile al colore Pantone da voi scelto.

**FRA****Couleurs spéciales**

Si, par malchance, vous ne parvenez pas à trouver la couleur que vous souhaitez dans la palette de notre gamme de couleurs standards, nous nous ferons un plaisir de la réaliser pour vous, selon les références Pantone, HKS et RAL. DS3 Biotic: le résultat sera aussi proche de votre couleur Pantone que la technologie le permet.

**CYR****Специальные цвета**

Если же по какой-либо случайности вы не сможете найти нужный вам цвет в нашем большом ассортименте, мы с радостью создадим его специально для вас, используя цветковые системы Pantone, RAL и HKS. DS3 Biotic: Результат соответствует цвету шкалы Pantone настолько, насколько это возможно технически.

**ENG****Mix & Match**

How does it work? Generally said you can mix colours, not surfaces. That remains true also when the chosen model has more than one surface as standard, for example a body in matt and a clip/button in polished: you can Mix & Match the colours as long as you keep the given mix of surfaces. For technical reasons Mix & Match is not possible for varnished, Soft Touch and Biotic surfaces.

**ESP****Mix & Match**

¿Cómo funciona esto? Por lo general se pueden mezclar colores, no superficies. Esto no deja de ser así si el modelo elegido tiene más de una superficie estándar, por ejemplo, un cuerpo en mate y un botón/clip pulido: puedes mezclar y combinar con Mix & Match los colores siempre y cuando conserves el mix de superficies establecido. Por razones técnicas el Mix & Match no está disponible en superficies barnizadas, Soft Touch y Biotic.

**DEU****Mix & Match**

Wie funktioniert Mix & Match? Generell können nur Farben, nicht jedoch Oberflächen, kombiniert werden. Das gilt auch für den Fall, dass das gewählte Modell standardmäßig mehr als eine Oberflächenbeschaffenheit besitzt, wie zum Beispiel eine matte Oberfläche für den Schaft und eine polierte Oberfläche für den Clip/Knopf. Farben können mit Mix & Match kombiniert werden, solange die vorgegebene Oberfläche beibehalten bleibt. Aus technischen Gründen steht Mix & Match nicht für lackierte, sowie für Soft Touch und Biotic Oberflächen zur Verfügung.

**ITA****Mix & Match**

Come funziona? In generale, si possono combinare solo i colori, non le superfici. Ciò vale anche se il modello selezionato prevede come standard più di una superficie, per esempio, un corpo opaco e clip/pulsante lucidi: tramite Mix & Match possono essere combinati i colori purché rimanga invariato il mix di superfici stabilito. Per motivi tecnici il Mix & Match non è disponibile per superfici verniciate, Soft Touch e Biotic.

**FRA****Mix & Match**

Qu'est-ce que c'est ? En général, vous pouvez mélanger les couleurs, pas les surfaces. Cette possibilité est également offerte sur un modèle qui comporte plusieurs surfaces en standard, par exemple corps du stylo mat et agrafe/bouton-poussoir poli. Tant que vous conservez l'association initiale des surfaces, vous pouvez procéder à un Mix & Match de couleurs. Pour des raisons techniques, Mix & Match est impossible avec les surfaces laquées, Soft Touch et Biotic.

**CYR****Смешивание и Сочетание**

Как это работает? В общих чертах, вы можете смешивать цвета, но не поверхности. Это справедливо также, если у выбранной модели больше одной поверхности в стандартной комплектации, например, матовый корпус и полированные зажим/кнопка. Вы можете смешивать и сочетать цвета, пока сохраняется первоначально выбранное сочетание поверхностей. По техническим причинам Смешивание и Сочетание невозможно для глянцевых поверхностей, поверхностей софт-тач и биотик.

DS3



**Fastlane**

Delivered 5 working days after the customer's approval.  
From 500 to 5.000 pcs.  
No ring option.

F - Frosted

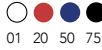

T - Transparent

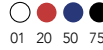

P - Polished



nose cone

C - Chrome finish metal\*



Floating Ball®  
Jumbo refill



\*Not available with frosted surface



print areas

A clip

40 x 8 mm  
1,57" x 0,31"  
5 colours

DS5



**Fastlane**

Delivered 5 working days after the customer's approval.  
From 500 to 5.000 pcs.  
No clip cover option.

F - Frosted

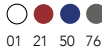

T - Transparent



M - Matt



nose cone

C - Chrome finish metal\*



Floating Ball®  
Jumbo refill

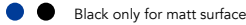

Black only for matt surface

\*Available with transparent surface



print areas

A clip

40 x 7 mm  
1,57" x 0,28"  
5 colours

DS9



**Fastlane**

Delivered 5 working days after the customer's approval.  
From 500 to 5.000 pcs.

M - Matt (with polished clip)



button

Y - Galvanised satin



nose cone

S - Satin finish metal



Floating Ball®  
Jumbo refill



Z - Galvanised chrome



ring\*

T - Transparent

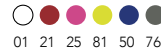

P - Polished

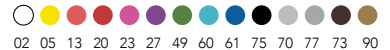

\*Ring option not available with galvanised satin and chrome button



print areas

A clip

43 x 8 mm  
1,70" x 0,31"  
5 colours

## ENG

**Artwork**

In order to meet your requirements regarding our DS, QS, DNA and PS products, we need to receive your layout. A digital file of your artwork allows the fastest processing and produces the best results. We can also process material in a printed format.

**Vectorised files**

- Adobe Illustrator (.ai)
- Freehand (.fh)
- Coreldraw (.cdr)
- InDesign (.indd)
- or .eps/.pdf formats generated by these programmes.

Please remember to add notes about photographs, pictures and special fonts used in your file.

**Bitmap files**

- bmp, .tiff, .jpg or .gif format
- Minimum resolution 1:1. 1'200 dpi for lines and text
- Minimum resolution 1:1. 300 dpi for photographs (CMYK) and screened logos

**Printed material**

- Format 1:2
- Laser prints at a minimum resolution of 600 dpi

**Technical design**

Upon request, we would be happy to provide you with the respective technical design (.pdf, .eps) for any product. Your graphic designer or agency needs these templates to design the layout.

**Design proposals / Layouts**

If you currently don't work with a graphic designer or agency, please don't hesitate to contact us. Our graphics will design the products for you – in line with your ideas. In addition to a short written briefing to describe your ideas, you will also need to send us the digital artwork in the best possible quality.

**What is possible?****Colours DS, QS & DNA**

We can print every colour within the Pantone ("C" colours), HKS ("K" colours) and RAL ranges. Please always specify which colour (reference number for one of the colour scales mentioned above) is to be placed for each position. We print in 5 fluorescent colours too (yellow, green, pink, orange, sunset orange) on P02, M02, P77 and M77 surfaces.

**Colours and Font size / Packagings**

The PS2 boxes, sleeve options PS4 and cover PS6 are produced using the classic four-colour process. This technique is particularly suited to the reproduction of images and illustrations. Basic colours cyan, magenta, yellow and black are mixed up to create full colours. The result is matched to your Pantone colour as closely as technically possible. The colour of a letter is the result of the over-lapping of two or more colours via four-colour processing. Very small or fine letters (< 6 points) may cause problems in readability. For special requests or requirements, please contact us via telephone or email. We're always glad to help you.

**Font size DS, QS & DNA**

Fonts should always be vector files (PATH). We generally recommend font sizes starting from 4 pt. The maximum size possible depends on the printable area available.

**Stroke weight**

The minimum stroke weight and line distance depends on what is technically feasible and legible:

- stroke weight:  $\geq 0,1$  mm
- line distance:  $\geq 0,1$  mm

**Laser Engraving**

Available for the galvanised push button of the DS2, the metal clips of DS8 and B-module of DNA.

**Inlays DS5****Image Inlay**

With this option, a paper element can be inserted into the clip. The inlay is printed with the classic four-colour process. This technique is particularly suited to the reproduction of photos and illustrations. If you prefer colours from the Pantone scale (PMS) for your inlay, they are mixed from the basic colours (cyan, magenta, yellow and black). The result is matched as closely as technically possible to the Pantone colours.

**Approval of production proof****Production proof**

As soon as we receive your printing details, we will send you an e-mail showing colours, position and print size. Please check all information thoroughly. If you are satisfied with the result, please send us your approval of the production proof. Upon receipt of this approval we start the production.

**Corrections**

If you would like to make changes, please send us a detailed email. Please also make sure that corrections are legible. Prior to printing, we will send you by e-mail a new draft with the changes. Once again, you are kindly asked to check the proof and send us your approval.

**Additional information****Orders**

Please use the full order codes and specify all requirements, e.g. ink colour. This will help to speed up the process.

**Products and prices**

You will find the order code and volume-dependent unit price of our products in our price lists.

**Terms and conditions**

Our terms and conditions are outlined in our price lists.

**Shipping-Packaging**

Our products are packed into bulks of 50/100 pcs each and shipped into cartons for 500/1.000 pcs. Models DS2, DS3.1, DS5, DS6, DS7 and DS9 are packed into Bulk 50's, while DS1, DS3, DS8, and QS are packed into Bulk 100's. In addition to our standard boxes all products can be delivered in different packagings: PS2, PS4, PS5, PS6 and polybag. PS4, PS5, PS6 and polybag. DNA is individually packed in a transparent box.

**Get in touch**

Although we are committed to providing you with all necessary information in our catalogue, you may have specific questions that remain unanswered. If you have any queries, please don't hesitate to contact us. By phone, e-mail or visit our website. We look forward to hearing from you.

## DEU

**Druckvorlagen**

Um DS, QS, DNA und PS Produkte nach Ihren Vorstellungen personalisieren zu können, benötigen wir Druckvorlagen von Ihnen. Digitale Vorlagen garantieren beste Ergebnisse und schnellste Verarbeitung. Gedruckte Vorlagen sind auch möglich.

**Vektorisierte Dateien**

- Adobe Illustrator (.ai)
- Freehand (.fh)
- Coreldraw (.cdr)
- InDesign (.indd)
- oder .eps bzw. .pdf-Formate von diesen Programmen.

Bitte vergessen Sie nicht, Fotos, Bilder und eventuell besondere Schriftsätze mit den entsprechenden Hinweisen Ihrem Ordner beizufügen.

**Bitmap Dateien**

- .bmp, .tiff, .jpg oder .gif
- Mindestauflösung 1:1. 1.200 dpi für Linien und Texte
- Mindestauflösung 1:1. 300 dpi für Fotos (CMYK) und gerasterte Logos

**Drucksachen**

- Format 1:2
- Laserausdrucke mit einer Mindestauflösung von 600 dpi

**Technisches Datenblatt**

Für jedes Produkt stellen wir Ihnen auf Anfrage gern die entsprechenden digitalen (.pdf, .eps) Datenblätter zur Verfügung. Ihre Agentur/Grafiker brauchen diese für die Gestaltung des Layouts.

**Gestaltungsvorschläge / Grafik**

Sollten Sie mit keinem Grafiker bzw. mit keiner Agentur arbeiten, können Sie sich an uns wenden. Unsere Grafiker gestalten gern die gewünschten Produkte, ganz nach Ihren Vorstellungen. Neben einem kurzen schriftlichen Briefing, in dem Sie uns Ihre Vorstellungen erläutern, benötigen wir dazu digitale Vorlagen in bestmöglicher Qualität.

**Machbares****Farben DS, QS und DNA**

Wir können jede Farbe der Skalen Pantone ("C" Farben), HKS ("K" Farben) und RAL drucken. Bitte geben Sie bei der Druckvorlage an, welche Farbe (Referenznummer in einer der genannten Farbskalen) wo platziert werden soll. Wir drucken auch 5 Neon-Farben (Gelb, Grün, Pink, Orange, Sunset-Orange) auf den Oberflächen P02, M02, P77 und M77.

**Farben und Schriftgrösse / Verpackungen**

Die PS2 Boxen, PS4 Kartonschuber und PS6 Deckel werden in klassischem Vierfarbdruck realisiert. Diese Technik eignet sich besonders für die Wiedergabe von Bildern und Illustrationen. Vollfarben der Pantone-Skala (PMS) werden aus den Grundfarben Cyan, Magenta, Gelb und Schwarz gemischt. Das Ergebnis ist Ihrer Pantone-Farbe so nah wie technisch möglich. Der Farbton eines Buchstabens wird im Vierfarbdruck durch die Überlagerung von zwei oder mehr Farben erzielt. Bei sehr kleinen oder feinen Buchstaben (< 6 Punkt) kann dies die Lesbarkeit beeinträchtigen. Bei speziellen Anforderungen oder Sonderwünschen wenden Sie sich bitte per Telefon oder Email an uns – wir freuen uns, Ihnen weiterzuhelfen.

**Schriftgrösse DS, QS und DNA**

Schriftzüge sollten wenn möglich vektorisierte Dateien sein (PATH). Im Regelfall empfehlen wir Buchstabengrößen ab 4 Punkt. Nach oben ist die Buchstabengrösse durch die jeweilige Druckfläche begrenzt.

**Strichstärke**

- Minimale Strichstärke und Liniendistanz werden von den Grenzen des technisch Machbaren und optisch Wahrnehmbaren bestimmt:
- Strichstärke:  $\geq 0,1$  mm
- Liniendistanz:  $\geq 0,1$  mm

**Lasergravur**

Machbar auf dem galvanisierten Druckknopf des DS2 sowie auf den Metall-Clips der Modelle DS8 und auf B-Modul von DNA.

**Inlays DS5****Build-Inlay**

Bei dieser Option wird ein Papierelement in den Clip eingelegt. Diese Technik eignet sich besonders für die Wiedergabe von Bildern und Illustrationen (klassischer Vierfarbdruck). Sollten Sie für Ihren Einleger Vollfarben der Pantone-Skala (PMS) wünschen, werden sie aus den Grundfarben (Cyan, Magenta, Gelb und Schwarz) gemischt. Das Ergebnis ist dem Pantone-Farbton so nah wie technisch möglich.

**Druckfreigabe****Vorschau**

Nach Erhalt Ihrer Druckvorlage schicken wir Ihnen umgehend eine E-Mail, auf denen Farben, Druckstand und Druckgrösse genau zu erkennen sind. Bitte prüfen Sie alle hier gemachten Angaben. Wenn alles zu Ihrer Zufriedenheit ist, geben Sie uns bitte so schnell wie möglich Ihre Freigabe zum Druck – wir starten dann umgehend die Produktion.

**Korrekturen**

Sollten Sie Korrekturen wünschen, informieren Sie uns bitte im Detail per E-Mail. Zur endgültigen Freigabe erhalten Sie nochmals eine neue Druckfreigabe per E-Mail mit allen Änderungen. Auch hier gilt: Je früher wir grünes Licht von Ihnen bekommen, desto schneller können wir mit der Produktion beginnen.

**Weitere Informationen****Aufträge**

Bitte verwenden Sie die vollständigen Bestell-Codes und präzisieren Sie alle gewünschten Details, z.B. die Schreibfarbe. So helfen Sie uns, Ihren Auftrag so schnell wie möglich abzuwickeln.

**Produkte und Preise**

Die Bestell-Codes und mengenabhängigen Stückpreise unserer Produkte finden Sie in unseren Preislisten.

**Liefer- und Zahlungsbedingungen**

Unsere Allgemeinen Geschäftsbedingungen finden Sie in unseren Preislisten.

**Versand-Verpackung**

All unsere Produkte werden in kleinen Schachteln zu 50/100 Stück verpackt und anschliessend in Umkartons zu 500/1.000 Stück. Die Modelle DS2, DS3.1, DS5, DS6, DS7 und DS9 werden in Schachteln zu 50 Stück verpackt, die Modelle DS1, DS3, DS8, und QS zu je 100 Stück. Zusätzlich zu diesen Standardverpackungen können unsere Produkte in alternativen Verpackungen konfektioniert werden: PS2, PS4, PS5 und PS6. DNA wird einzeln in einem transparenten Etui verpackt. Details und Kosten sind der Preisliste zu entnehmen.

**Kontaktieren Sie uns**

Obwohl wir uns bemühen, alle Informationen klar aufzubereiten, kann unser Katalog vielleicht nicht alle Fragen beantworten. Rufen Sie uns gern an, besuchen Sie uns im Internet, schicken Sie uns eine E-Mail, wenn noch etwas offen sein sollte. Wir freuen uns, von Ihnen zu hören.

## FRA

## Maquettes d'imprimerie

Afin de pouvoir personnaliser vos accessoires d'écriture DS, QS, DNA et PS exactement selon vos conceptions, nous avons besoin de vos maquettes d'imprimerie. Des maquettes numérisées garantissent les meilleurs résultats et le traitement le plus rapide. Mais nous pouvons également travailler avec des modèles imprimés.

### Fichiers vectoriels

- Adobe Illustrator (.ai)
- Freehand (.fh)
- Coreldraw (.cdr)
- InDesign (.indd)
- ou bien formats .eps ou .pdf de ces programmes.

N'oubliez pas s.v.p. d'ajouter à votre dossier avec les indications correspondantes des photos, des illustrations et des polices.

### Fichiers bitmap

- Formats .bmp, .tiff, .jpg ou .gif
- Résolution minimale 1:1. 1200 dpi pour les lignes et les textes
- Résolution minimale 1:1. 300 dpi pour les photographies (CMYK) et les logos tramés

## Imprimés

- Format 1:2
- Imprimés au laser avec une résolution minimale de 600 dpi

## Fiche technique

Pour tous les produits nous vous fournissons volontiers une fiche technique (.pdf, .eps) correspondant. Votre graphiste ou votre agence a besoin de ce modèle pour la réalisation de la maquette.

## Propositions de maquettes / Conception graphique

Si vous ne disposez pas d'un graphiste ou ne collaborez pas avec une agence, vous pouvez faire appel à nos services. Nos graphistes réaliseront les maquettes souhaitées. Bien entendu, en entière conformité avec vos idées. En plus des indications écrites où vous expliquez brièvement ce que vous souhaitez, nous avons besoin de documents numériques de la meilleure qualité possible (voir ci-dessus).

## Ce qui est faisable

### Couleurs DS, QS et DNA

Dans le cadre de ce qui est faisable nous imprimons pour vous toutes couleurs des échelles Pantone (couleurs "C"), HKS (couleurs "K") et RAL. Veuillez s.v.p. toujours indiquer sur la maquette d'imprimerie quelle couleur (numéro de référence dans l'une des échelles de couleurs mentionnées) doit être placée à quel endroit. Nous imprimons aussi 5 couleurs néon (jaune, vert, rosé, orange, sunset orange) sur tous les surfaces P02, M02, P77 et M77.

### Couleurs et taille des caractères / Emballages

Les boîtes PS2, l'option carton du PS4 et la couverture PS6 sont réalisées selon le procédé classique d'impression en quadrichromie. Cette technologie s'adapte particulièrement bien à la reproduction d'images et d'illustrations. Les couleurs du nuancier Pantone (PMS) sont obtenues par le mélange des couleurs primaires cyan, magenta, jaune et noir. Le résultat sera aussi proche de votre couleur Pantone que la technologie le permet. En quadrichromie, la teinte d'une lettre s'obtient par la superposition de deux ou plusieurs couleurs. Avec les caractères très petits et fins (< 6 points), la lisibilité peut être affectée. En cas de requêtes spécifiques ou exceptionnelles, veuillez nous contacter par téléphone ou e-mail. Nous serons heureux de vous aider à résoudre vos problèmes.

### Taille des caractères DS, QS et DNA

Les caractères doivent être en format vectorisé (PATH). En règle générale, nous recommandons des tailles de caractères à partir de 4 points. Vers le haut, la taille des caractères est limitée par la surface d'impression offerte par l'accessoire d'écriture du cas considéré.

### Épaisseur des traits

Le minimum concernant l'épaisseur des traits et la distance entre les lignes est déterminé par les limites de ce qui est techniquement faisable et perceptible du point de vue optique:

- épaisseur de trait minimale:  $\geq 0,1$  mm
- distance entre les lignes:  $\geq 0,1$  mm

### Gravure Laser

Réalisable sur le bouton-poussoir galvanisé du DS2 ainsi que sur l'agrafes métal du modèles DS8 et sur le module B du DNA.

## Inserts DS5

### Insert image

Dans cette option, un insert papier est glissé dans l'agrafe (clip-cover). Cet insert est imprimé en quadrichromie, une technique qui convient tout particulièrement à la reproduction des photos et des illustrations. Si vous souhaitez utiliser pour ces inserts les coloris de la gamme Pantone (PMS), nous les réalisons par combinaison des couleurs fondamentales (cyan, magenta, jaune et noir). Le résultat est aussi proche que possible de la nuance Pantone.

## Autorisation d'impression

### Bon à tirer

Dès réception de votre BAT, nous vous adressons un message électronique sur lequel les couleurs, l'emplacement et la taille de l'impression sont exactement visibles. Veuillez s.v.p. vérifier toutes les indications qui sont faites ici et nous donner le plus rapidement possible votre autorisation d'impression. C'est seulement après cela que nous démarrons la production.

### Corrections

Au cas où vous souhaiteriez encore d'autres corrections, nous vous prions de nous les détailler par e-mail. Vous recevrez alors encore une fois un message électronique avec les modifications pour une autorisation définitive d'impression.

## Informations supplémentaires

### Commandes

Nous vous prions de bien vouloir utiliser les codes de commande complets et de préciser tous les détails souhaités, par exemple la couleur de l'encre. Vous nous aidez ainsi à exécuter votre commande le plus rapidement possible.

### Produits et prix

Vous trouverez le code de commande et le prix unitaire dépendant de la quantité commandée de nos produits dans notre barème.

### Conditions de livraison et de paiement

Vous trouverez nos Conditions Commerciales Générales dans nos barèmes.

### Expédition-Emballage

Nos produits sont emballés dans des boîtes de 50 ou 100 pièces et envoyés dans des cartons de 500 ou 1000 pièces. Les modèles DS2, DS3.1, DS5, DS6, DS7 et DS9 sont emballés dans des boîtes de 50 pièces et les modèles DS1, DS3, DS8 et QS dans des boîtes de 100 pièces. En supplément de nos emballages standards, nos produits peuvent être emballés dans suivantes boîtes: PS2, PS4, PS5, PS6 et Polybag. DNA est emballé individuellement dans une emballage transparent.

### Nous vous aidons

Bien que nous nous efforcions de préparer clairement toutes les informations, il se peut que notre catalogue ne réponde pas à toutes les questions. Appelez-nous, rendez-nous visite sur Internet, envoyez nous un message électronique si il y a des détails qui ne sont pas encore totalement clair pour vous.

## ESP

**Plantillas de impresión**

Para poder personalizar sus artículos DS, QS, DNA y PS conforme a sus deseos personales, necesitamos que nos facilite plantillas de impresión. Las plantillas de impresión en formato digital garantizan los mejores resultados y un procesamiento más rápido. También podemos trabajar con plantillas impresas.

**Archivos vectorizados**

- Adobe Illustrator (.ai)
- Freehand (.fh)
- Coreldraw (.cdr)
- InDesign (.indd)
- o formatos .eps o .pdf de estos programas.

Por favor, no olvide adjuntar instrucciones especiales para fotos, ilustraciones y escritura.

**Archivos bitmap**

- Formatos .bmp, .tiff, .jpg o .gif
- Resolución mínima 1:1. 1.200 dpi para líneas y textos
- Resolución mínima 1:1. 300 dpi para fotos (CMYK) y logotipos reticulados

**Impresos**

- Formato 1:2
- Impresiones láser con una resolución mínima de 600 dpi

**Plantillas**

Para todos los productos le facilitaremos si lo desea las Plantillas digitales (.pdf, .eps) correspondientes. Su grafista o su agencia necesitan esta hoja para diseñar el layout.

**Diseño técnico / Gráfico**

Si no tiene ningún grafista o ninguna agencia, puede dirigirse a nosotros. Nuestros grafistas diseñan los productos deseados. Naturalmente, completamente según sus deseos. Le pediremos un breve resumen escrito en el que nos explique sus ideas, junto a su diseño gráfico de la mejor calidad posible (véase arriba).

**Lo realizable****Colores DS, QS y DNA**

Podemos imprimir en todos los colores de las escalas Pantone ("C" colores), HKS ("K" colores) y RAL. Indique siempre en la plantilla de impresión qué color (número de referencia en una de las escalas de color indicadas) debe ubicarse y dónde. Nosotros imprimimos también 5 colores fluorescentes (amarillo, verde, rosado, naranja, sunset orange) en las superficies P02, M02, P77 y M77.

**Colores y tamaño de letra / Estuches**

Las cajas PS2, la capa de cartón del PS4 y la cubierta de cartón del PS6 se realizan en la impresión clásica a cuatro colores. Esta técnica es especialmente idónea para la reproducción de imágenes e ilustraciones. Los colores puros de la escala Pantone (PMS) se mezclan con los colores básicos cyan, magenta, amarillo y negro. El resultado se ajustará a su color Pantone tanto como sea posible técnicamente.

El tono de color de una letra se obtiene en impresión a cuatro colores con la superposición de dos o más colores. Cuando las letras son muy pequeñas o finas (< 6 puntos) esto puede perjudicar la legibilidad. Si existen requisitos o deseos especiales, póngase en contacto con nosotros por teléfono o Email. Nos complace poder ayudarle.

**Tamaño de letra DS, QS y DNA**

Los textos tienen que ser en formato vectorizado (PATH). Normalmente, recomendamos tamaños de letra a partir de 4 puntos. El tamaño de letra máximo está limitado por la superficie impresa del artículo de escritura.

**Grosor de línea**

El grosor de línea mínimo y la distancia entre líneas están determinados por los límites de lo técnicamente realizable y lo visualmente perceptible:

- grosor de línea:  $\geq 0,1$  mm
- distancia entre líneas:  $\geq 0,1$  mm

**Grabado láser**

Es factible con el pulsante galvanizado del DS2 así como con el clip metálico del modelo DS8 y el módulo B del DNA.

**Inserciones DS5****Inserción gráfica**

En esta opción se inserta un elemento de papel en el clip (tapa de clip). Las inserciones se imprimen en cuatricromía. Esta técnica es especialmente indicada para la reproducción de imágenes e ilustraciones. Si desea para su inserción colores de la escala Pantone (PMS), se compondrán mezclando los colores básicos (cyan, magenta, amarillo y negro). El resultado se ajustará a su color Pantone tanto como sea posible técnicamente.

**Autorización de la impresión****Apto para imprimir**

Después de recibir su plantilla de impresión, le enviaremos un correo electrónico en el que puedan apreciarse claramente los colores, la situación de la impresión y el tamaño de la misma. Por favor, compruebe todos los datos aquí indicados. Si todo es correcto, le rogamos nos envíe con la mayor brevedad posible su autorización para la impresión. Solamente entonces iniciaremos la producción.

**Correcciones**

Si desea realizar otras correcciones, comuníquenoslas en detalle por correo electrónico. Para la autorización definitiva recibirá nuevamente un correo electrónico con las modificaciones.

**Otras informaciones****Pedidos**

Utilice siempre el código de pedido completo y precise todos los detalles deseados, por ejemplo, el color de la tinta. De este modo, nos ayudará a gestionar su pedido lo más rápidamente posible.

**Productos y precios**

En nuestra lista de precios encontrará el código de pedido y el precio unitario de nuestros productos, en función de la cantidad.

**Condiciones de suministro y pago**

Encontrará nuestras condiciones comerciales generales en nuestras listas de precios.

**Envío- Embalaje**

Nuestros productos se empaquetan en cajitas de 50/100 unidades y se envían en cajas de 500/1000 unidades. Los modelos DS2, DS3.1, DS5, DS6, DS7 y DS9 se empaquetan en cajitas de 50 unidades, mientras que los modelos DS1, DS3, DS8 y QS se empaquetan en cajitas de 100 unidades. Además de nuestras cajas estándar todos nuestros productos pueden ser enviados en las confecciones: PS2, PS4, PS5, PS6 y Polybag. DNA se empaqueta individualmente en una caja transparente.

**Seguiremos prestándole servicio**

Aunque nos esforcemos por preparar claramente todas las informaciones, quizá nuestro catálogo no responda a todas las preguntas. Llámenos, visítenos en Internet, envíenos un correo electrónico si desea aclarar alguna duda.

ITA

## Progetto di stampa

Per personalizzare i vostri prodotti DS, QS, DNA e PS esattamente secondo le vostre esigenze, abbiamo bisogno dei vostri progetti di stampa. I migliori risultati e la lavorazione più rapida si ottengono con file digitali. Si accettano anche stampati.

### File vettoriali

- Adobe Illustrator (.ai)
- Freehand (.fh)
- Coreldraw (.cdr)
- InDesign (.indd)
- oppure formati .eps e .pdf di questi programmi.

Si prega di non dimenticare di fornire eventuali annotazioni su foto, immagini e caratteri di scrittura.

### File bitmap

- Formati .bmp, .tiff, .jpg o .gif
- Risoluzione minima 1:1. 1.200 dpi per linee e testi
- Risoluzione minima 1:1. 300 dpi per foto (CMYK) e loghi con retino

## Stampati

- Formato 1:2
- Stampe laser con risoluzione minima di 600 dpi

## Disegni tecnici

È possibile richiedere il disegno tecnico (.pdf, .eps) per tutti i prodotti, affinché il vostro grafico o la vostra agenzia possano creare il layout correttamente.

## Progetti / Grafica

Se non disponete di un supporto grafico, potete rivolgervi a noi. I nostri grafici sapranno creare un prodotto su misura per voi sulla base delle vostre indicazioni. Vi chiediamo una descrizione scritta delle vostre idee, oltre a file digitali della miglior qualità possibile (vedi sopra).

## Fattibilità

### Colori DS, QS e DNA

Nel limite del fattibile stampiamo tutti i colori delle scale Pantone (colori "C"), HKS (colori "K") e RAL. Si prega di indicare sempre sul progetto di stampa quale colore (numero di riferimento in una delle scale cromatiche menzionate) è da utilizzarsi e per quale posizione. Stampiamo anche 5 colori fluo (giallo, verde, rosa, arancio, sunset orange) sulle superfici P02, M02, P77 e M77.

### Colori e dimensione dei caratteri / Astucci

I PS2, opzione rivestimento per PS4 e cover PS6 vengono realizzati con la classica quadricromia. Questa tecnica è particolarmente adatta per la riproduzione di immagini e illustrazioni. I colori vengono creati mescolando i colori primari ciano, magenta, giallo e nero. Il risultato, nei limiti tecnici, si avvicinerà il più possibile al colore Pantone da voi scelto. La tonalità del colore di una lettera viene realizzata in quadricromia sovrapponendo due o più colori. Nel caso di lettere molto piccole o fini (< 6 punti) tutto ciò può comportare una riduzione della leggibilità. Nel caso di richieste o desideri particolari vi preghiamo di contattarci per telefono o e-mail. Saremo lieti di potervi aiutare.

### Dimensione dei caratteri DS, QS e DNA

I caratteri devono essere preferibilmente in tracciati (PATH). Di norma raccomandiamo caratteri con dimensione a partire da 4 punti. La dimensione massima realizzabile dei caratteri dipende dall'area di stampa del rispettivo strumento di scrittura.

### Spessore del tratto

Lo spessore minimo del tratto e la distanza fra le linee sono stabiliti dalla fattibilità a livello tecnico e dalla leggibilità:

- spessore del tratto:  $\geq 0,1$  mm
- distanza fra le linee:  $\geq 0,1$  mm

### Incisione Laser

Disponibile per il pulsante galvanizzato della DS2, e per le clip in metallo dei modelli DS8 e modulo B DNA.

## Inlay DS5

### Inlay ad immagini

Grazie a questa opzione è possibile inserire un elemento in carta nella clip (clip cover). Gli inserti vengono realizzati in quadricromia, una tecnica particolarmente adatta per la riproduzione di immagini e illustrazioni. Se per il vostro inserto desiderate dei colori della scala pantone (PMS), essi verranno creati mescolando i colori base (ciano, magenta, giallo e nero). Il risultato si avvicinerà il più possibile, sempre nei limiti tecnici, alla tonalità del pantone richiesto.

## Approvazione alla stampa

### Idoneità alla Stampa

Dopo aver ricevuto il vostro progetto di stampa, vi inviamo una bozza via e-mail, in cui indichiamo chiaramente colori, posizioni e dimensione di stampa. Si prega di controllare tutte le indicazioni riportate. Se è tutto come vi siete proposti, attendiamo la vostra tempestiva approvazione. Solo a questo punto potremo iniziare la produzione.

### Correzioni

Qualora desideriate apportare correzioni, vi preghiamo di comunicarle in modo dettagliato via email. Per l'approvazione definitiva riceverete una nuova bozza via e-mail con le modifiche apportate.

## Ulteriori informazioni

### Ordini

Si prega di utilizzare i codici di ordine completi e di precisare i dettagli desiderati, ad es. il colore dell'inchiostro. In questo modo ci aiutate ad evadere il vostro ordine nel modo più sollecito possibile.

### Prodotti e prezzi

Il codice e il prezzo unitario per quantità dei nostri prodotti sono indicati nel nostro listino prezzi.

### Condizioni di consegna e pagamento

Le nostre condizioni generali sono riportate nei nostri listini prezzi.

### Spedizione

Tutti i nostri prodotti vengono confezionati in scatole contenenti 50/100 pezzi e successivamente in cartoni da 500/1.000 pz. I modelli DS2, DS3.1, DS5, DS6, DS7 e DS9 sono confezionati in scatole da 50 pezzi, mentre i modelli DS1, DS3, DS8, e QS sono confezionati in scatole da 100 pezzi ciascuna. In alternativa, i nostri prodotti possono essere confezionati in appositi imballaggi: PS2, PS4, PS5, PS6 & Polybag. DNA è imballata singolarmente in una scatola trasparente.

### Ulteriore supporto per voi

Sebbene sia nostra intenzione rendere chiaramente accessibili tutte le informazioni, è possibile che il nostro catalogo non risponda a tutte le domande. Non esitate quindi a chiamarci, consultare il nostro sito Internet o a inviarci una e-mail, qualora qualcosa non fosse ancora ben chiaro.

CYR

## Изображения

Чтобы персонализировать Ваши изделия серий DS, QS, DNA и PS в соответствии с Вашими представлениями, нам нужны Ваши образцы для печати. Наилучшие результаты и максимально быструю обработку гарантируют цифровые образцы. Мы также можем работать с фильмами и печатными образцами.

### Векторные файлы

- Adobe Illustrator (.ai)
  - Freehand (.fh)
  - Coreldraw (.cdr)
  - InDesign (.indd)
  - или форматы .eps или .pdf этих программ.
- Пожалуйста, не забудьте приложить к Вашей папке фото, рисунки и возможные специальные шрифты с соответствующими указаниями.

### Файлы bitmap

- Форматы .bmp, .tiff, .jpg или .gif
- Минимальное разрешение 1:1: 1.200 dpi для линий и текстов
- Минимальное разрешение 1:1: 300 dpi для фотографий (СМУК) и растровых логотипов

## Пленки

- Формат 1:1
- На каждой пленке необходимо указать цвет.

## Графические Материалы

- Формат 1:2
- Распечатка на лазерном принтере с минимальным разрешением 600 dpi

## Выкройки

Для каждого продукта мы предоставим Вам соответствующий шаблон (в формате .eps или .pdf). Вашим художникам или Вашему агентству выкройки нужны для размещения на ней эскиза.

## Предложения по оформлению / графика

Если у Вас нет дизайнера или агентства, Вы можете совершенно спокойно обратиться к нам. За определенный гонорар наши художники создадут изделие серии Вашей мечты. Наряду с коротким письменным описанием Ваших представлений нам необходимо иметь цифровой оригинал максимально высокого качества (см. сверху).

## Возможности

### Цвета DS, QS и DNA

В пределах технических возможностей мы можем печатать любым цветом по шкалам Pantone («С» цветов), HKS («К» цветов) и RAL. Пожалуйста, всегда указывайте каждый цвет в соответствии с номером одной из выбранных Вами вышеперечисленных цветовых систем. Просим учесть также, что мы наносим изображение в 5 флуоресцент-ных цветах (желтый, зеленый, розовый, оран-жевый и оранжевый закат) на поверхно-стях P02, M02, P77 и M77.

### Цвета / Упаковки

Упаковки PS2, PS4 и поверхность PS6 производятся с помощью стандартной четырехцветной печати. Эта технология особенно подходит для передачи картинок и иллюстраций. Цветовая гамма цветовой шкалы Pantone (PMS) смешивается из основных цветов: циан, фуксин, желтый и черный. Результат соответствует цвету шкалы Pantone настолько, насколько это возможно технически. При наличии особых требова-ний или специальных пожеланий свяжитесь, пожалуйста, с нами по телефону, факсу или электронной почте. Мы будем рады оказать Вам помощь. Цвет буквы достигается технологией четырехцветной печати наложением двух или нескольких цветов. При очень маленьких или тонких буквах (< 6 pt) возможно нарушение четкости.

### Размер Шрифта DS, QS и DNA

Как правило, мы рекомендуем использовать высоту букв от 4 пунктов. В сторону увеличения высота букв ограничивается соответствующей площади печати на пишущем приборе.

### Толщина Штриха

Минимальная толщина штриха и расстояние между линиями определяется пределами технических возможностей и оптической восприимчивостью:

- толщина линий  $\geq 0,1$  mm
- расстояние между линиями  $\geq 0,1$  mm

### Лазерная гравировка

Доступна для гальванизированной кнопки DS2, металлического клипа DS8 и В- модуля модели DNA.

### Вклады DS5

#### Вкладка-Рисунок

Вклады исполняются в классической четырехцветной печати. Эта технология особенно подходит для воспроизведения картин и иллюстраций. Если Вы пожелаете использовать для Ваших вкладок цвета цветовой шкалы Pantone (PMS), то они изготавливаются смешиванием основных цветов (циан, фуксин, желтый и черный). Результат смешивания соответствует цветовому оттенку Pantone настолько, насколько это возможно технически.

## Утверждение Макета-Оригинала

### Печать Заказа

После получения от вас информации, необходимой для персонализации мы пошлем вам по электронной почте макет -оригинал, в котором указаны цвета, логотип, место размещения и размер наносимого изображения. Пожалуйста, тщательно проверьте всю эту информацию. Если вас все устраивает, пожалуйста, пришлите нам утвержденный макет. После этого заказ запускается в производство.

### Исправления

Если Вы хотите внести изменения, пожалуйста, опишите их детально и пришлите по e-mail. Просим убедиться, что Ваши исправления будут нам понятны. После внесения изменений, мы опять пошлем Вам макет на утверждение.

## Дополнительная Информация

### Заказы

Пожалуйста, используйте полный код заказа и уточняйте все необходимые детали, например, цвет чернил (пасты). Этим Вы можете нам выполнить Ваш заказ в кратчайшие сроки.

### Изделия и Цены

Код заказа и цену за единицу продукции в зависимости от объема заказа можно найти в нашем прайс-листе. Условия Поставки и Оплаты. Наши общие условия заключения торговых сделок находятся в прайс-листе.

### Отгрузка

Наши письменные приборы мы упаковываем в элегантные, изготовленные на заказ коробки по 50/100 шт и отгружаем в картонных коробках по 500/1000 шт. Модели DS1, DS3, DS8 и QS упакованы по 100 шт. Модели DS2, DS3.1, DS5, DS6, DS7 и DS9 поставляются в коробке по 50 шт. В дополнение к стандартной коробке, все наши модели могут поставляться в индивидуальной упаковке: PS2, PS4, PS5, PS6 и пластиковых пакетах. Модель DNA индивидуально упакована в прозрачную коробку.

### Дальнейшая Помощь

Хотя мы прилагаем все усилия для того, чтобы обеспечить Вас всей необходимой информацией, возможно, что наш каталог не сможет ответить на какие-то Ваши вопросы. Позвоните нам, посетите нас в Интернете, пошлите нам сообщение по электронной почте или факсом, если Вы хотите еще что-то дополнительно узнать.



**Concept,  
design and copy**  
Leftloft

**3D**  
RNDR Studio

**Photo**  
Mattia Balsamini

**Printed by**  
Grafiche Antiga

® 2018 Prodir  
CH – 6814 Lamone  
Switzerland  
[www.prodir.com](http://www.prodir.com)

prodir®

